

Statische berekening

Type Prunus

Projectnummer: 14300
Omschrijving: Plan Bull-Tabaksveld te Puiflijk
Documentnummer: 14300-S01
Datum: 29 januari 2016
Gewijzigd: -
Status: Definitief
Opdrachtgever: Bouwbedrijf Schot

Adviseur: ing. D. Anzion
d.anzion@constabiel.nl | 06 – 28 29 91 05

Colofon

Opdrachtgever en aannemer

Bouwbedrijf Schot
dhr. Dennis Papen
Postbus 117
7240 AC Lochem
0573 - 44 12 48
d.papen@bouwbedrijfschot.nl

Architect

G. Bull en Gemeente Druten

Opsteller rapportage

conStabiel | Adviseurs in Bouwtechniek

Opsteller: ing. D. Anzion

Interne controle: ing. J. Waalder

Projectteam: Adviseur constructie: ing. D. Anzion
Tekenaar: M. Rademaker

Inhoudsopgave

Colofon	2
Inhoudsopgave	3
1. Algemene constructiegegevens	4
2. Belastingaannee	6
3. Berekening	8
3.1 Mechanica kapconstructie	9
3.2 Nokgording	15
3.3 Houten topspant	19
3.4 Houten balklaag zoldervloer	24
3.5 Stalen liggers t.b.v. kap + vliering	25
3.6 Stalen ligger in rechterzijgevel t.p.v. de woonkamer	35
3.7 Stalen ligger in rechterzijgevel t.p.v. de entree	39
3.8 Stabiliteit	43
3.9 Controle oplegging op metselwerk	44
3.10 Gewichtsberekening	47
3.11 Funderingsbalken	49
3.12 Paal draagvermogen	69

1. Algemene constructiegegevens

Omschrijving bouwwerk

Het betreft de nieuwbouw van een woning, type Prunus.

Bouwkundige tekeningen

Deze berekening is gebaseerd op de bouwkundige tekeningen van conStabiel.

Gegevens derden

Voor deze berekening is gebruik gemaakt van de sonderingen en het funderingsadvies van Koops en Romeijn met opdrachtnummer 14.4068 d.d. 15 oktober 2014.

Uitgangspunten

Gebruikte normen:	NEN-EN Eurocode-serie	
Gebouwfunctie:	Niet in een woongebouw gelegen woning	
Gevolgklasse:	CC 1	
Ontwerp levensduur klasse:	3	
Ontwerp levensduur:	50 jaar	
Belastingfactoren:	permanent gunstig:	0,90
	permanent ongunstig niet dominant:	1,08
	permanent ongunstig dominant:	1,22
	veranderlijk:	1,35

Wind over- en onderdruk: Er is gerekend met een gesloten bouwwerk zonder dominante openingen.
Wateraccumulatie: Bij platte daken wordt een noodoverlaat of verlaagde dakrand toegepast.

Stabiliteit

De stabiliteit wordt voorzien door de schijfwerking van de verdiepingvloer en de kalkzandsteenwanden. In hoofdstuk 3.8 is een controle berekening gemaakt van de stabiliteit.

Brand

Het pand bestaat uit slechts een brandcompartiment en grenst niet aan een ander compartiment en er zijn geen vluchtwegen. Voor de constructie geldt geen brandwerendheidseis.

Materialen

Beton:	Sterkteklasse:	C20/25
	Milieuklasse:	XC2 tenzij anders aangegeven
	Wapening:	B500
Staal:	Kwaliteit walsprofielen:	S235
	Kwaliteit kokerprofielen:	S235
	Kwaliteit ankers:	4.6
	Kwaliteit bouten:	8.8
Hout:	Kwaliteit gezaagd hout:	C24
Kalkzandsteen:	Kwaliteit steen:	CS12
	Kwaliteit mortel/lijm:	lijmwerk
	Representatieve muurdruk:	6,6 N/mm ²

Constructie onderdelen

Kapconstructie:	Gordingenkap met prefab dakplaten.
Vliering:	Houten balklaag met underlayment.
Verdiepingsvloer:	Kanaalplaatvloer dik 200 mm conform tekening en berekening leverancier. Ter plaatse van tegelvloeren de afwerklaag voorzien van vezels of krimpwapening #Ø4-150. De stukken ter controle indienen bij de hoofdconstructeur.
Beganegrondvloer:	Kanaalplaatvloer dik 200 mm conform tekening en berekening leverancier. Ter plaatse van tegelvloeren de afwerklaag voorzien van vezels of krimpwapening #Ø4-150. De stukken ter controle indienen bij de hoofdconstructeur.
Fundering:	Fundering op mortelschroefpalen conform funderingsadvies.

Prefab beton onderdelen

Werkzaamheden voor de prefab onderdelen dienen te worden uitgevoerd conform de onderstaande categorieën volgens het KOMO-atteest:

Categorie 2:	Palen
Categorie 4:	Systeembloeren
Categorie 5:	Wanden

Staalconstructie

Definitieve details, detailberekeningen, (vloer)ravelingen, sparingen, anker- en boutverbindingen, tijdelijke voorzieningen voor montage en uitvoering en lateien en geveldragers zijn uit te voeren conform opgave van de leverancier.

Staalconstructies en verankeringen in vochtig milieu corrosiewerend behandelen, met een referentieperiode van 50 jaar.

Overige constructie uitgangspunten:

Dilataties:	Er zijn geen constructieve dilataties voorzien. Materiaalgebonden dilataties dienen te worden aangegeven door de betreffende leveranciers.
Terreingegevens:	Bouwpeil: Onbekend
Bouwput:	Voorzieningen ten behoeve van bouwput en bemaling conform opgave van de aannemer.

2. Belastingaanneمة

Windbelasting	Windgebied	III	$\Psi_0 = 0$			
	Terreincategorie	III	$\Psi_1 = 0,2$			
	h =	9,1 m	$\Psi_2 = 0$			
	d =	8,9 m				
	b =	6,0 m				
	e =	6,0 m				
	$q_p =$	0,53 kN/m ²				
Coëfficiënten gevel	zone A	zone B	zone C	zone D	zone E	
	-1,20	-0,80	-0,50	0,80	-0,50	
Coëfficiënten hellend dak	zone F	zone G	zone H	zone I	zone J	
	0,00	0,70	0,00	0,70	0,00	0,67 -0,20 -0,30
Coëfficiënten inwendige druk	intern					
	0,20	-0,30				
Sneeuwbelasting	Zadeldak symmetrisch	dakhelling 1	55 graden	$\mu_1 = 0,13$	$Q_{sn;k} =$	0,09 kN/m ²
Dakconstructie	Dakhelling	55 graden				
	Eigen gewicht pannendak	0,65 / cos	55	=	1,13 kN/m ²	(grondvlak)
Zoldervloer	Eigen gewicht balklaag				0,30 kN/m ²	
	Plafond				0,10 -	
	Vloerhout				0,10 -	
	Totaal permanente belasting				<u>0,50 kN/m²</u>	
Veranderlijke belasting					1,75 kN/m ²	$\Psi_0 = 0,4$
Verplaatsbare scheidingswanden					0,50 -	$\Psi_1 = 0,5$
					<u>2,25 kN/m²</u>	$\Psi_2 = 0,3$
Verdiepingsvloer	Kanaalplaatvloer	dik 200 mm			3,80 kN/m ²	
	Afwerklaag	dik 60 mm			1,20 -	
	Totaal permanente belasting				<u>5,00 kN/m²</u>	
Veranderlijke belasting					1,75 kN/m ²	$\Psi_0 = 0,4$
Verplaatsbare scheidingswanden					0,80 -	$\Psi_1 = 0,5$
					<u>2,55 kN/m²</u>	$\Psi_2 = 0,3$
Beganegrondvloer	Kanaalplaatvloer	dik 200 mm			3,40 kN/m ²	
	Afwerklaag	dik 60 mm			1,20 -	
	Totaal permanente belasting				<u>4,60 kN/m²</u>	
Veranderlijke belasting					1,75 kN/m ²	$\Psi_0 = 0,4$
Verplaatsbare scheidingswanden					0,80 -	$\Psi_1 = 0,5$
					<u>2,55 kN/m²</u>	$\Psi_2 = 0,3$

Wanden

Metselwerk	dik	100	mm	2,00	kN/m ²
Kalkzandsteen	dik	100	mm	1,85	-
Kalkzandsteen	dik	120	mm	2,22	-
HSB-gevel				0,50	-

3. Berekening

3.1 Mechanica kapconstructie

belastingbreedte 1,00 m

Belastingen q_1

permanent	1,00	*	1,13	=	1,13 kN/m
veranderlijk					kN/m
sneeuw I	1,00	*	0,09	=	0,09 kN/m
sneeuw II	1,00	*	0,09	=	0,09 kN/m
wind	1,00	*	0,97	*	0,53 = 0,51 kN/m

Belastingen q_2

permanent	1,00	*	1,13	=	1,13 kN/m
veranderlijk					kN/m
sneeuw I	1,00	*	0,09	=	0,09 kN/m
sneeuw II	1,00	*	0,09	*	0,50 = 0,05 kN/m
wind	1,00	*	0,10	*	0,53 = 0,05 kN/m

TS/Raamwerken

Rel: 6.04 20 jan 2016

Project..: 14300 | Plan Bull-Tabaksveld te Puiflijk
 Onderdeel: Mechanica kapconstructie
 Dimensies: kN/m/rad (tenzij anders aangegeven)
 Datum...: 12/01/2016
 Bestand..: P:\14300\Algemeen\conStabiel\Statische berekening\Prunus\
 Mechanica kapconstructie.rww

Theorie voor de bepaling van de krachtsverdeling: Geometrisch lineair.

Gunstige werking van de permanente belasting wordt automatisch verwerkt

Toegepaste normen volgens Eurocode met Nederlandse NB

Belastingen	NEN-EN 1990:2002	C2:2010	NB:2011(nl)
	NEN-EN 1991-1-1:2002	C1:2009	NB:2011(nl)

GEOMETRIE

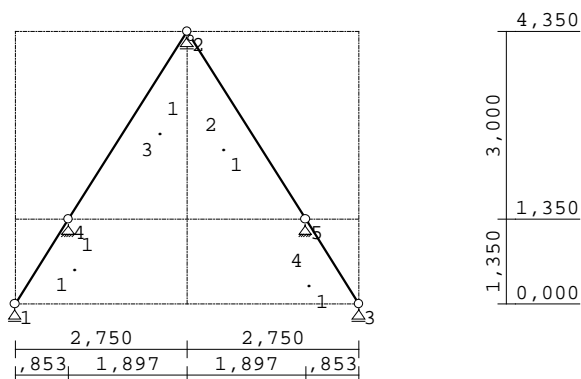

STRAMIENLIJNEN

Nr.	X	Z-min	Z-max
1	0.000	0.000	4.350
2	2.750	0.000	4.350
3	5.500	0.000	4.350

NIVEAUS

Nr.	Z	X-min	X-max
1	0.000	0.000	5.500
2	1.350	0.000	5.500
3	4.350	0.000	5.500

MATERIALEN

Mt Omschrijving	E-modulus[N/mm ²]	S.M.	S.M.verhoogd	Pois.	Uitz. coëff
1 C18	9000	3.2	3.8	1.00	5.0000e-006

Bij de bepaling v.h. e.g. van houten staven is de S.M.verhoogd toegepast.

PROFIELEN [mm]

Prof.	Omschrijving	Materiaal	Oppervlak	Traagheid	Vormf.
1	B*H 71*196	1:C18	1.3916e+004	4.4550e+007	0.00

PROFIELEN vervolg [mm]

Prof.	Staaftype	Breedte	Hoogte	e	Type	b1	h1	b2	h2
1	0:Normaal	71	196	98.0	0:RH				

PROFIELVORMEN [mm]

1 B*H 71*196



KNOPEN

Knoop	X	Z
1	0.000	0.000
2	2.750	4.350
3	5.500	0.000
4	0.853	1.350
5	4.647	1.350

STAVEN

St.	ki	kj	Profiel	Aansl.i	Aansl.j	Lengte	Opm.
1	1	4	1:B*H 71*196	NDM	NDM	1.597	
2	2	5	1:B*H 71*196	ND-	NDM	3.549	
3	4	2	1:B*H 71*196	NDM	NDM	3.549	
4	5	3	1:B*H 71*196	NDM	NDM	1.597	

VASTE STEUNPUNTEN

Nr.	knoop	Kode	XZR	l=vast	0=vrij	Hoek
1	1	010				0.00
2	2	010				0.00
3	3	010				0.00
4	4	110				0.00
5	5	110				0.00

BELASTINGGEVALLEN

B.G.	Omschrijving	EGZ	Type
1	Permanente belasting	-1.00	1
2	Sneeuw belasting I		22 Sneeuw A
3	Sneeuw belasting II		23 Sneeuw B
4	Wind belasting		7 Wind van links onderdruk A

BELASTINGEN

B.G:1 Permanente belasting

Eigen gewicht van alle staven is meegenomen in berekening. Richting:↓

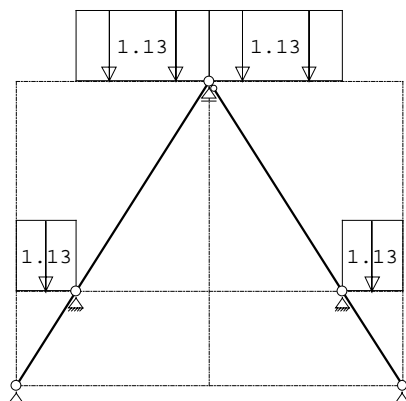

STAAFBELASTINGEN

B.G:1 Permanente belasting

StAAF	Type	q1/p/m	q2	A	B	Ψ_0	Ψ_1	Ψ_2
1	3:QZgeProj.	-1.13	-1.13	0.000	0.000			
3	3:QZgeProj.	-1.13	-1.13	0.000	0.000			
2	3:QZgeProj.	-1.13	-1.13	0.000	0.000			
4	3:QZgeProj.	-1.13	-1.13	0.000	0.000			

REACTIES

B.G:1 Permanente belasting

Kn.	X	Z	M
1		0.04	
2		2.21	
3		0.04	
4	-0.10	2.24	
5	0.10	2.24	
	0.00	6.77	: Som van de reacties
	0.00	-6.77	: Som van de belastingen

BELASTINGEN

B.G:2 Sneeuw belasting I

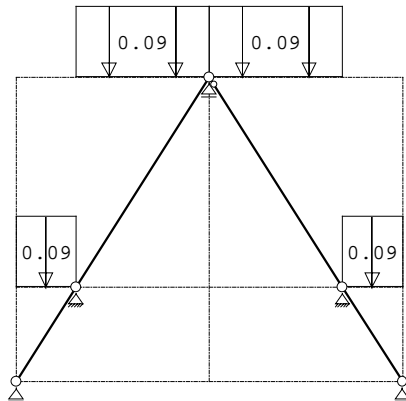

STAAFBELASTINGEN

B.G:2 Sneeuw belasting I

Staaftype	Type	q1/p/m	q2	A	B	Ψ_0	Ψ_1	Ψ_2
1	3:QZgeProj.	-0.09	-0.09	0.000	0.000	0.0	0.2	0.0
3	3:QZgeProj.	-0.09	-0.09	0.000	0.000	0.0	0.2	0.0
2	3:QZgeProj.	-0.09	-0.09	0.000	0.000	0.0	0.2	0.0
4	3:QZgeProj.	-0.09	-0.09	0.000	0.000	0.0	0.2	0.0

REACTIES

B.G:2 Sneeuw belasting I

Kn.	X	Z	M
1		0.00	
2		0.16	
3		0.00	
4	-0.01	0.16	
5	0.01	0.16	
	0.00	0.50	: Som van de reacties
	0.00	-0.50	: Som van de belastingen

BELASTINGEN

B.G:3 Sneeuw belasting II

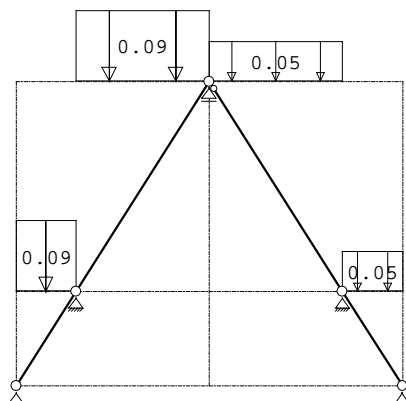

STAAFBELASTINGEN

B.G:3 Sneeuw belasting II

Staaftype	Type	q1/p/m	q2	A	B	Ψ_0	Ψ_1	Ψ_2
1	3:QZgeProj.	-0.09	-0.09	0.000	0.000	0.0	0.2	0.0
3	3:QZgeProj.	-0.09	-0.09	0.000	0.000	0.0	0.2	0.0
2	3:QZgeProj.	-0.05	-0.05	0.000	0.000	0.0	0.2	0.0
4	3:QZgeProj.	-0.05	-0.05	0.000	0.000	0.0	0.2	0.0

REACTIES

B.G:3 Sneeuw belasting II

Kn.	X	Z	M
1		0.00	
2		0.13	
3		0.00	
4	-0.01	0.17	
5	0.01	0.09	
	0.00	0.39	: Som van de reacties
	0.00	-0.39	: Som van de belastingen

BELASTINGEN

B.G:4 Wind belasting

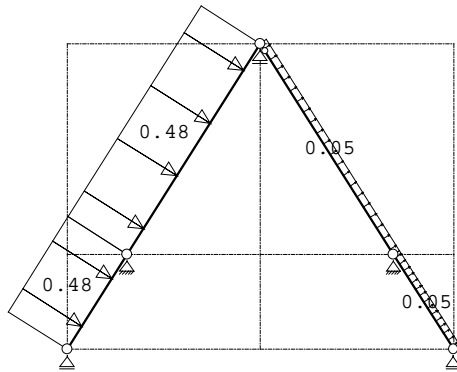

STAAFBELASTINGEN

B.G:4 Wind belasting

Staat	Type	q1/p/m	q2	A	B	Ψ_0	Ψ_1	Ψ_2
1	1:QZLokaal	-0.48	-0.48	0.000	0.000	0.0	0.2	0.0
3	1:QZLokaal	-0.48	-0.48	0.000	0.000	0.0	0.2	0.0
2	1:QZLokaal	0.05	0.05	0.000	0.000	0.0	0.2	0.0
4	1:QZLokaal	0.05	0.05	0.000	0.000	0.0	0.2	0.0

REACTIES

B.G:4 Wind belasting

Kn.	X	Z	M
1		0.05	
2		0.33	
3		-0.00	
4	-1.83	0.39	
5	-0.48	0.41	
	-2.31	1.18	: Som van de reacties
	2.31	-1.18	: Som van de belastingen

BELASTINGCOMBINATIES

BC	Type			
1	Fund.	1.08 $G_{k,1}$	+	1.35 $Q_{k,2}$
2	Fund.	1.08 $G_{k,1}$	+	1.35 $Q_{k,3}$
3	Fund.	1.08 $G_{k,1}$	+	1.35 $Q_{k,4}$
4	Fund.	1.22 $G_{k,1}$	+	1.35 $\Psi_0 Q_{k,2}$
5	Fund.	1.22 $G_{k,1}$	+	1.35 $\Psi_0 Q_{k,3}$
6	Fund.	1.22 $G_{k,1}$	+	1.35 $\Psi_0 Q_{k,4}$
7	Kar.	1.00 $G_{k,1}$	+	1.00 $Q_{k,2}$
8	Kar.	1.00 $G_{k,1}$	+	1.00 $Q_{k,3}$
9	Kar.	1.00 $G_{k,1}$	+	1.00 $Q_{k,4}$
10	Kar.	1.00 $G_{k,1}$	+	1.00 $\Psi_0 Q_{k,2}$
11	Kar.	1.00 $G_{k,1}$	+	1.00 $\Psi_0 Q_{k,3}$
12	Kar.	1.00 $G_{k,1}$	+	1.00 $\Psi_0 Q_{k,4}$
13	Quas.	1.00 $G_{k,1}$	+	1.00 $\Psi_2 Q_{k,2}$
14	Quas.	1.00 $G_{k,1}$	+	1.00 $\Psi_2 Q_{k,3}$
15	Quas.	1.00 $G_{k,1}$	+	1.00 $\Psi_2 Q_{k,4}$
16	Freq.	1.00 $G_{k,1}$	+	1.00 $\Psi_1 Q_{k,2}$
17	Freq.	1.00 $G_{k,1}$	+	1.00 $\Psi_1 Q_{k,3}$
18	Freq.	1.00 $G_{k,1}$	+	1.00 $\Psi_1 Q_{k,4}$
19	Blij.	1.00 $G_{k,1}$		

GUNSTIGE WERKING PERMANENTE BELASTINGEN

BC Staven met gunstige werking

- 1 Geen
- 2 Geen
- 3 Geen
- 4 Geen
- 5 Geen
- 6 Geen

OMHULLENDE VAN DE FUNDAMENTELE COMBINATIES

MOMENTEN

Fundamentele combinatie

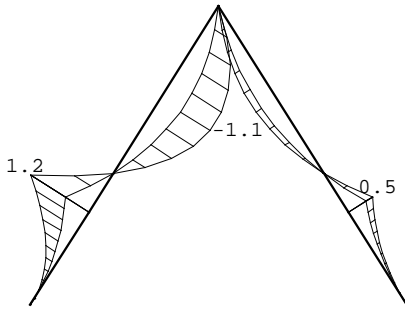

DWARSKRACHTEN

Fundamentele combinatie

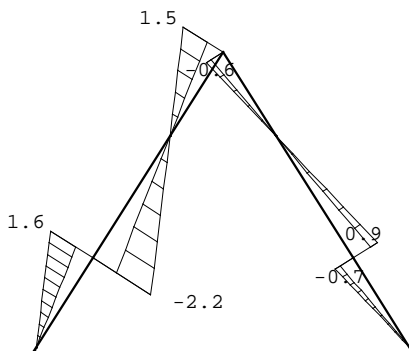

NORMAALKRACHTEN

Fundamentele combinatie

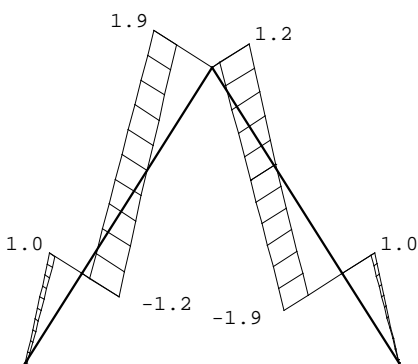

REACTIES

Fundamentele combinatie

Kn.	X-min	X-max	Z-min	Z-max	M-min	M-max
1			0.05	0.11		
2			2.55	2.83		
3			0.04	0.05		
4	-2.57	-0.11	2.64	2.95		
5	-0.54	0.12	2.54	2.98		

OMHULLENDE VAN DE KARAKTERISTIEKE COMBINATIES

VERPLAATSINGEN

[mm]

Karakteristieke combinatie

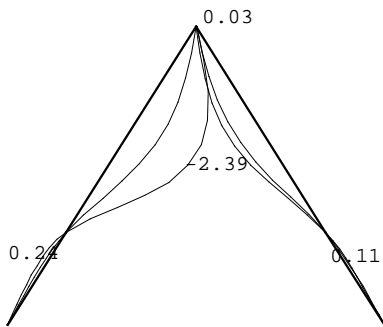

REACTIES

Karakteristieke combinatie

Kn.	X-min	X-max	Z-min	Z-max	M-min	M-max
1			0.04	0.09		
2			2.21	2.54		
3			0.04	0.04		
4	-1.93	-0.10	2.24	2.63		
5	-0.38	0.11	2.24	2.65		

3.2 Nokgording

$Q_{perm.}; kapconstructie = 2,21 \text{ kN/m}^1$

$Q_{ver.}; wind = 0,33 \text{ kN/m}^1$

TS/Liggers

Rel: 6.10 20 jan 2016

Project.....: 14300 - Plan Bull-Tabaksveld te Puiflijk
 Onderdeel....: Nokgording
 Constructeur.: ing. D. Anzion
 Opdrachtgever: Bouwbedrijf Schot
 Dimensies....: kN/m/rad
 Datum.....: 19/01/2016
 Bestand.....: p:\14300\algemeen\constabiel\statische berekening\prunus\nokgording.dlw

Betrouwbaarheidsklasse : 1 Referentieperiode : 50

Toegepaste normen volgens Eurocode met Nederlandse NB

Belastingen	NEN-EN 1990:2002	C2:2010	NB:2011(nl)
	NEN-EN 1991-1-1:2002	C1:2009	NB:2011(nl)
Hout	NEN-EN 1995-1-1:2005	A1:2011,C1:2006	NB:2011(nl)

GEOMETRIE

Ligger:1

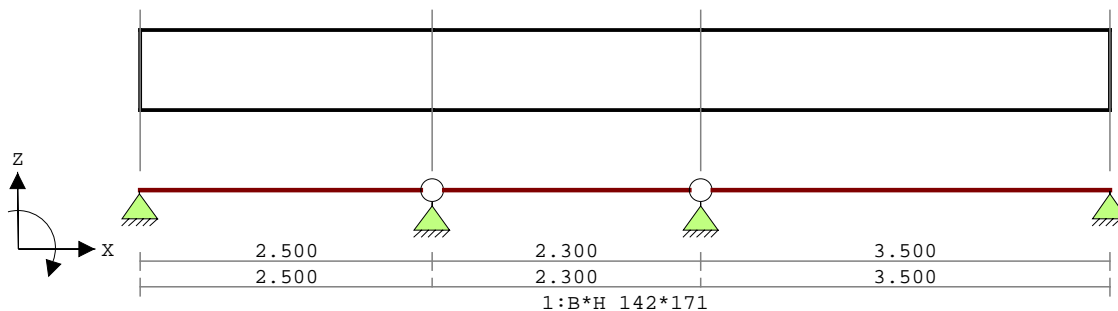

VELDLONGTEN

Ligger:1

Veld	Vanaf	Tot	Lengte
1	0.000	2.500	2.500
2	2.500	4.800	2.300
3	4.800	8.300	3.500

MATERIALEN

Mt Omschrijving E-modulus[N/mm²] S.M. S.M.verhoogd Pois. Uitz. coëff

1 C24 11000 3.5 4.2 0.00 5.0000e-006

Bij de bepaling v.h. e.g. van houten staven is de S.M.verhoogd toegepast.

PROFIELEN [mm]

Prof. Omschrijving	Materiaal	Oppervlak	Traagheid	Vormf.
1 B*H 142*171	1:C24	2.4282e+004	5.9169e+007	0.00

PROFIELEN vervolg [mm]

Prof.	Staaftype	Breedte	Hoogte	e	Type	b1	h1	b2	h2
1	0:Normaal	142	171	85.5	0:RH				

DOORSNEDEN

Ligger:1

sector	Vanaf	Tot	Lengte	Profiel begin	z-begin	Profiel eind	z-eind
1	0.000	2.500	2.500	1:B*H 142*171	0.000	1:B*H 142*171	0.000
2	2.500	4.800	2.300	1:B*H 142*171	0.000	1:B*H 142*171	0.000
3	4.800	8.300	3.500	1:B*H 142*171	0.000	1:B*H 142*171	0.000

sector Vanaf Tot Lengte Eindcode Bedding Br.[mm]

1	0.000	2.500	2.500	0:Scharnier	
2	2.500	4.800	2.300	0:Scharnier	
3	4.800	8.300	3.500	1:Vast	

BELASTINGGEVALLEN

B.G.	Omschrijving	Belast/onbelast	ψ_0	ψ_1	ψ_2	e.g.
1	Permanent	2:Permanent EN1991				-1.00
2	Veranderlijk	1:Schaakbord EN1991	0.40	0.50	0.30	0.00

BELASTINGGEVALLEN

B.G.	Omschrijving	Type
1	Permanent	1 Permanente belasting
2	Veranderlijk	2 Ver. bel. pers. ed. (p_rep)

VELDBELASTINGEN

Ligger:1 B.G:1 Permanent

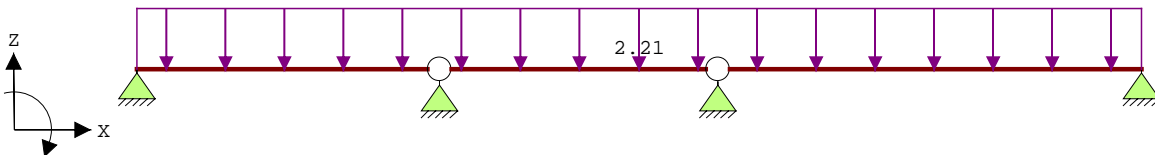

VELDBELASTINGEN

Ligger:1 B.G:1 Permanent

Last Ref.	Type	Omschrijving	q1/p/m	q2	psi	Afstand	Lengte
1	1:q-last		-2.210	-2.210		0.000	8.300

REACTIES

Ligger:1 B.G:1 Permanent

Stp	F	M
1	2.89	0.00
2	5.55	0.00
3	6.70	0.00
4	4.05	0.00

19.19 : (absoluut) grootste som reacties
 -19.19 : (absoluut) grootste som belastingen

VELDBELASTINGEN

Ligger:1 B.G:2 Veranderlijk

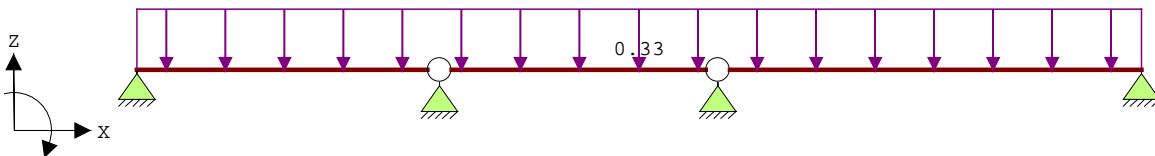

VELDBELASTINGEN

Ligger:1 B.G:2 Veranderlijk

Last Ref.	Type	Omschrijving	q1/p/m	q2	psi	Afstand	Lengte
1	1:q-last		-0.330	-0.330		0.000	8.300

REACTIES

Ligger:1 B.G:2 Veranderlijk

Stp	Fmin	Fmax	Mmin	Mmax
1	0.00	0.41	0.00	0.00
2	0.00	0.79	0.00	0.00
3	0.00	0.96	0.00	0.00
4	0.00	0.58	0.00	0.00

BELASTINGCOMBINATIES

BC	Type	BG	Gen.	Factor	BG	Gen.	Factor	BG	Gen.	Factor	BG	Gen.	Factor
1	Fund.	1	Perm	1.22									
2	Fund.	1	Perm	0.90									
3	Fund.	1	Perm	1.22	2	psi0	1.35						
4	Fund.	1	Perm	1.08	2	Extr	1.35						
5	Fund.	1	Perm	0.90	2	Extr	1.35						
6	Fund.	1	Perm	0.90	2	psi0	1.35						
7	Kar.	1	Perm	1.00	2	Extr	1.00						
8	Quas.	1	Perm	1.00									
9	Quas.	1	Perm	1.00	2	psi2	1.00						
10	Freq.	1	Perm	1.00									
11	Freq.	1	Perm	1.00	2	psi1	1.00						
12	Blij.	1	Perm	1.00									

GUNSTIGE WERKING PERMANENTE BELASTINGEN

BC Velden met gunstige werking

- 1 Geen
- 2 Alle velden de factor:0.90
- 3 Geen
- 4 Geen
- 5 Alle velden de factor:0.90
- 6 Alle velden de factor:0.90

OMHULLENDE VAN DE FUNDAMENTELE COMBINATIES

MOMENTEN

Ligger:1 Fundamentele combinatie

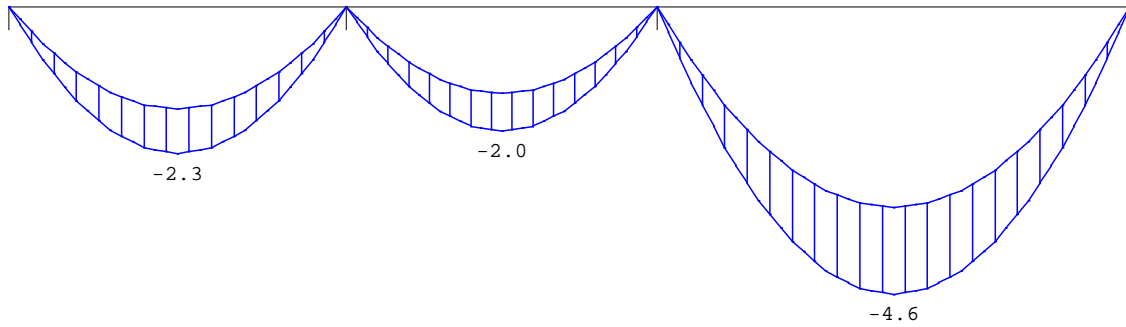

DWARSKRACHTEN

Ligger:1 Fundamentele combinatie

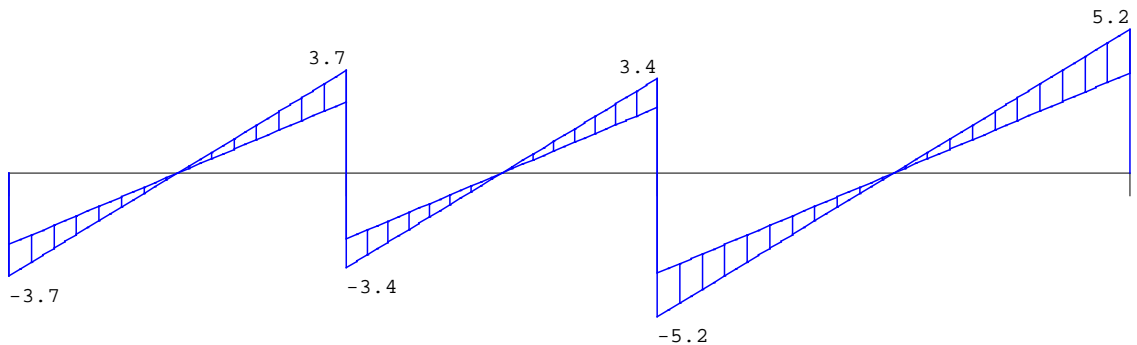

Fmin:2.60
Fmax:3.73

4.99
7.2

6.0
8.7

3.64
5.2

REACTIES

Ligger:1 Fundamentele combinatie

Stp	Fmin	Fmax	Mmin	Mmax
1	2.60	3.73	0.00	0.00
2	4.99	7.17	0.00	0.00
3	6.03	8.66	0.00	0.00
4	3.64	5.23	0.00	0.00

OMHULLENDE VAN DE KARAKTERISTIEKE COMBINATIES

VERPLAATSINGEN [mm]

Ligger:1 Karakteristieke combinatie

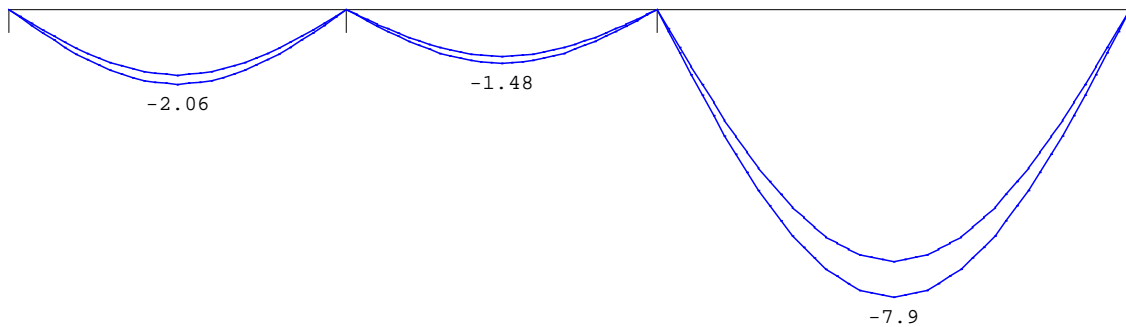

N.B. In deze verplaatsingen is de kruipvervorming (w2) niet verwerkt!

MATERIAALGEGEVENS

Materiaal	$f_{m,y,k}$ [N/mm ²]	ρ_k [kg/m ³]	ρ_{mean} [kg/m ³]	$f_{t,0,k}$ [N/mm ²]	$f_{t,90,k}$ [N/mm ²]	$f_{c,0,k}$ [N/mm ²]	$f_{c,90,k}$ [N/mm ²]	$f_{v,k}$ [N/mm ²]
C24	24	350	420	14	0.4	21	2.5	4.0

MATERIAALGEGEVENS (vervolg)

Materiaal	G_{mean} [N/mm ²]	$E_{0,05}$ [N/mm ²]	$E_{90,mean}$ [N/mm ²]	$E_{0,mean}$ [N/mm ²]	Klimaatklasse	k_{def}	$E_{0,mean,fin}$ [N/mm ²]
C24	690	7400	370	11000	I	0.60	6875

KIPSTABILITEIT

Ligger:1

StAAF	Plts. aanr.	l sys. [m]	Kipsteunafstanden [m]
1	1.0*h	boven: 2.50	0.000;2.500 2.50 0.000;2.500
2	1.0*h	boven: 2.30	2.300 2.30 2.300
3	1.0*h	boven: 3.50	3.500 3.50 3.500

STABILITEIT

StAAF	positie [mm]	$l_{ef,y}$ [mm]	$\sigma_{my,crit}$ [N/mm ²]	$\lambda_{rel,my}$	$k_{crit,y}$
1	1250	2592	262.59	0.30	1.00
2	1150	2412	282.18	0.29	1.00
3	1750	3492	194.91	0.35	1.00

TOETSING SPANNINGEN

StAAF	1	BC / Sit.	3 / 1	UC frm(6.11)	0.30
StAAF	2	BC / Sit.	3 / 1	UC frm(6.11)	0.26
StAAF	3	BC / Sit.	3 / 1	UC frm(6.11)	0.60

TOETSING DOORBUIGING

Stf	Soort	l_{sys} [mm]	Overstek i j	BC Sit	u_{bij} [mm]	Toelaatbaar *1	$u_{fin,net}$ [mm]	Toelaatbaar *1
1	Vloer	2500	Nee Nee	9 1	-1.4	-7.5 0.003	-3.2	-10.0 0.004
2	Vloer	2300	Nee Nee	9 1	-1.0	-6.9 0.003	-2.3	-9.2 0.004
3	Vloer	3500	Nee Nee	9 1	-5.3	-10.5 0.003	-12.3	-14.0 0.004

TOETSING DOORBUIGING (vervolg)

Stf	Soort	l_{sys} [mm]	Overstek i j	BC Sit	u_{inst} [mm]	Toelaatbaar *1
1	Vloer	2500	Nee Nee	7 1	-2.1	-10.0 0.004
2	Vloer	2300	Nee Nee	7 1	-1.5	-9.2 0.004
3	Vloer	3500	Nee Nee	7 1	-7.9	-14.0 0.004

3.3 Houten topspant

$F_{perm.; Nokgording} = 6,70 \text{ kN}$

$F_{ver.; Nokgording} = 0,96 \text{ kN}$

TS/Raamwerken

Rel: 6.04a 29 jan 2016

Project..: 14300 - Plan Bull-Tabaksveld te Puiflijk
 Onderdeel: Houten topspant
 Dimensies: kN;m;rad (tenzij anders aangegeven)
 Datum....: 12/01/2016
 Bestand..: P:\14300\Algemeen\conStabiel\Statische berekening\Prunus\
 Houten topspant.rww

Rekenmodel.....: 2e-orde-elastisch.
 Theorieën voor de bepaling van de krachtsverdeling:

- 1) Losse belastinggevallen:
 Lineaire-elasticiteitstheorie
- 2) Uiterste grenstoestand:
 Geometrisch niet lineair alle staven.
 Fysisch lineair alle staven.
- 3) Gebruiksgrenstoestand:
 Lineaire-elasticiteitstheorie

Maximum aantal iteraties.....: 50
 Max.deellengte kolommen/wanden: 0.500 Max.deellengte balken/vloeren: 0.500
 Max. X-verplaatsing in UGT....: 0.500 Max. Z-verplaatsing in UGT...: 0.250

Gunstige werking van de permanente belasting wordt automatisch verwerkt

Toegepaste normen volgens Eurocode met Nederlandse NB

Belastingen	NEN-EN 1990:2002	C2:2010	NB:2011(nl)
	NEN-EN 1991-1-1:2002	C1:2009	NB:2011(nl)
Hout	NEN-EN 1995-1-1:2005	A1:2011, C1:2006	NB:2011(nl)

GEOMETRIE

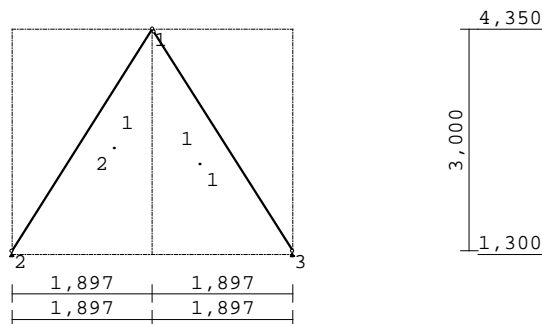

STRAMIENLIJNEN

Nr.	X	Z-min	Z-max
1	0.853	1.300	4.350
2	2.750	1.300	4.350
3	4.647	1.300	4.350

NIVEAUS

Nr.	Z	X-min	X-max
1	1.300	0.853	4.647
2	4.350	0.853	4.647

MATERIALEN

Mt	Omschrijving	E-modulus[N/mm ²]	S.M.	S.M.verhoogd	Pois.	Uitz. coëff
1	C24	11000	3.5	4.2	0.00	5.0000e-006

Bij de bepaling v.h. e.g. van houten staven is de S.M.verhoogd toegepast.

PROFIELEN [mm]

Prof.	Omschrijving	Materiaal	Oppervlak	Traagheid	Vormf.
1	B*H 71*171	1:C24	1.2141e+004	2.9585e+007	0.00

PROFIELEN vervolg [mm]

Prof.	Staaftype	Breedte	Hoogte	e	Type	b1	h1	b2	h2
1	0:Normaal	71	171	85.5	0:RH				

PROFIELVORMEN [mm]

1 B*H 71*171



KNOPEN

Knoop	X	Z
1	2.750	4.350
2	0.853	1.350
3	4.647	1.350

STAVEN

St.	ki	kj	Profiel	Aansl.i	Aansl.j	Lengte	Opm.
1	1	3	1:B*H 71*171	ND-	NDM	3.549	
2	2	1	1:B*H 71*171	NDM	NDM	3.549	

VASTE STEUNPUNTEN

Nr.	knoop	Kode	XZR	l=vast	0=vrij	Hoek
1	2	110				0.00
2	3	110				0.00

BELASTINGGEVALLEN

B.G.	Omschrijving	Type
1	Permanente belasting	EGZ=-1.00 1
2	Sneeuw belasting	22 Sneeuw A

BELASTINGEN

B.G:1 Permanente belasting

Eigen gewicht van alle staven is meegenomen in berekening. Richting:↓

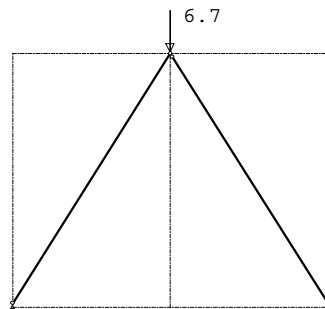

KNOOPBELASTINGEN

B.G:1 Permanente belasting

Last	Knoop	Richting	waarde	ψ_0	ψ_1	ψ_2
1	1	Z	-6.700			

REACTIES

1e orde

B.G:1 Permanente belasting

Kn.	X	Z	M
2	2.18	3.53	
3	-2.18	3.53	
	0.00	7.06	: Som van de reacties
	0.00	-7.06	: Som van de belastingen

BELASTINGEN

B.G:2 Sneeuw belasting

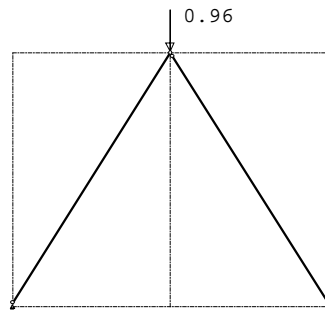

KNOOPBELASTINGEN

B.G:2 Sneeuw belasting

Last	Knoop	Richting	waarde	ψ_0	ψ_1	ψ_2
1	1	Z	-0.960	0.0	0.2	0.0

REACTIES

1e orde

B.G:2 Sneeuw belasting

Kn.	X	Z	M
2	0.30	0.48	
3	-0.30	0.48	
	0.00	0.96	: Som van de reacties
	0.00	-0.96	: Som van de belastingen

BEREKENINGSTATUS

B.C.	Iteratie	Status
1	3	Nauwkeurigheid bereikt
2	3	Nauwkeurigheid bereikt
3	1	Lineaire berekening
4	1	Lineaire berekening
5	1	Lineaire berekening
6	1	Lineaire berekening
7	1	Lineaire berekening

BELASTINGCOMBINATIES

BC	Type				
1	Fund.	1.08	$G_{k,1}$	+	1.35 $Q_{k,2}$
2	Fund.	1.22	$G_{k,1}$	+	1.35 $\psi_0 Q_{k,2}$
3	Kar.	1.00	$G_{k,1}$	+	1.00 $Q_{k,2}$
4	Kar.	1.00	$G_{k,1}$	+	1.00 $\psi_0 Q_{k,2}$
5	Quas.	1.00	$G_{k,1}$	+	1.00 $\psi_2 Q_{k,2}$
6	Freq.	1.00	$G_{k,1}$	+	1.00 $\psi_1 Q_{k,2}$
7	Blij.	1.00	$G_{k,1}$		

GUNSTIGE WERKING PERMANENTE BELASTINGEN

BC	Staven met gunstige werking
1	Geen
2	Geen

OMHULLENDE VAN DE FUNDAMENTELE COMBINATIES

MOMENTEN

2e orde

Fundamentele combinatie

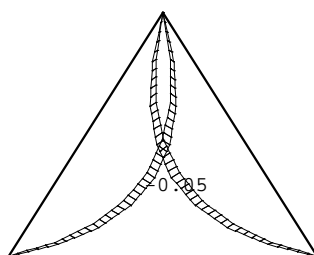

DWARSKRACHTEN

2e orde

Fundamentele combinatie

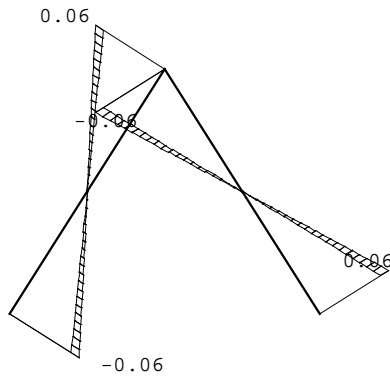

NORMAALKRACHTEN

2e orde

Fundamentele combinatie

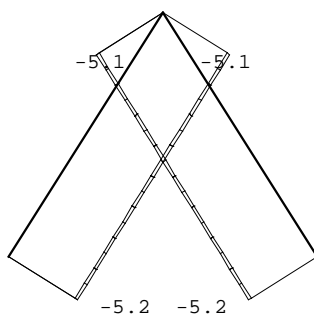

REACTIES

2e orde

Fundamentele combinatie

Kn.	X-min	X-max	Z-min	Z-max	M-min	M-max
2	2.65	2.76	4.31	4.46		
3	-2.76	-2.65	4.31	4.46		

OMHULLENDE VAN DE KARAKTERISTIEKE COMBINATIES

VERPLAATSINGEN

1e orde [mm]

Karakteristieke combinatie

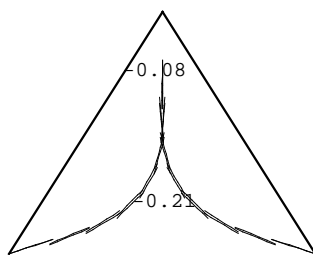

REACTIES

1e orde

Karakteristieke combinatie

Kn.	X-min	X-max	Z-min	Z-max	M-min	M-max
2	2.18	2.48	3.53	4.01		
3	-2.48	-2.18	3.53	4.01		

MATERIAALGEGEVENS

Materiaal	$f_{m,y,k}$ [N/mm ²]	ρ_k [kg/m ³]	ρ_{mean} [kg/m ³]	$f_{t,0,k}$ [N/mm ²]	$f_{t,90,k}$ [N/mm ²]	$f_{c,0,k}$ [N/mm ²]	$f_{c,90,k}$ [N/mm ²]	$f_{v,k}$ [N/mm ²]
C24	24	350	420	14	0.4	21	2.5	4.0

MATERIAALGEGEVENS (vervolg)

Materiaal	G_{mean} [N/mm ²]	$E_{0,05}$ [N/mm ²]	E_{90mean} [N/mm ²]	$E_{0,mean}$ [N/mm ²]	Klimaatklasse	k_{def}	$E_{0mean,fin}$ [N/mm ²]
C24	690	7400	370	11000	I	0.60	6875

KIPSTABILITEIT

Staaft	Plts. aangr.	l sys. [m]	Kipsteunafstanden [m]
1	1.0*h	boven:	3.55 0;3.549
		onder:	3.55 0;3.549
2	1.0*h	boven:	3.55 0;3.549
		onder:	3.55 0;3.549

STABILITEIT

Stf	b_{gem} [mm]	h_{gem} [mm]	l_{sys} [mm]	$l_{buc,y/z}$ [mm]	λ_y	λ_z	$\lambda_{rel,y/z}$	β_c	k_y	k_z	$k_{c,y}$	$k_{c,z}$		
1	71	171	3549	3549	3549	71.9	173.2	1.219	2.936	0.2	1.335	5.075	0.532	0.109
2	71	171	3549	3549	3549	71.9	173.2	1.219	2.936	0.2	1.335	5.075	0.532	0.109

TOETSING SPANNINGEN

Staaft 1 BC / Sit. 1 / 1 UC frm(6.24) 0.41

Maatg. is norm.drukkr. + buiging (EN 1995-1-1 art. 6.3.2(3)) aan bovenzijde staaft

Positie	1774	[mm]	Breedte	71.00	[mm]	Hoogte	171.00	[mm]
k_{mod}	0.60	[-]	k_h	1.00	[-]	$k_{h(fmk, ftok)}$	1.00	[-]
$f_{m,y,d}$	11.08	[N/mm ²]	$f_{c,0,d}$	9.69	[N/mm ²]	$f_{t,0,d}$	6.46	[N/mm ²]
$f_{v,d}$	1.85	[N/mm ²]	$f_{c,90,d}$	1.15	[N/mm ²]	$f_{t,90,d}$	0.18	[N/mm ²]
N	-5.16	[kN]	D	-0.00	[kN]	M	-0.05	[kNm]
$\sigma_{c,0,d}$	0.43	[N/mm ²]	$\sigma_{v,d}$	0.00	[N/mm ²]	$\sigma_{m,y,d}$	-0.14	[N/mm ²]
$k_{c,z}$	0.11	[-]	k_m	0.70	[-]	$l_{ef,y}$	3536.10	[mm]
$\sigma_{my,crit}$	48.12	[N/mm ²]	$\lambda_{rel,my}$	0.71	[-]	$k_{crit,y}$	1.00	[-]

Staaft 2 BC / Sit. 1 / 1 UC frm(6.24) 0.41

Maatg. is norm.drukkr. + buiging (EN 1995-1-1 art. 6.3.2(3)) aan bovenzijde staaft

Positie	1774	[mm]	Breedte	71.00	[mm]	Hoogte	171.00	[mm]
k_{mod}	0.60	[-]	k_h	1.00	[-]	$k_{h(fmk, ftok)}$	1.00	[-]
$f_{m,y,d}$	11.08	[N/mm ²]	$f_{c,0,d}$	9.69	[N/mm ²]	$f_{t,0,d}$	6.46	[N/mm ²]
$f_{v,d}$	1.85	[N/mm ²]	$f_{c,90,d}$	1.15	[N/mm ²]	$f_{t,90,d}$	0.18	[N/mm ²]
N	-5.16	[kN]	D	-0.00	[kN]	M	-0.05	[kNm]
$\sigma_{c,0,d}$	0.43	[N/mm ²]	$\sigma_{v,d}$	0.00	[N/mm ²]	$\sigma_{m,y,d}$	-0.14	[N/mm ²]
$k_{c,z}$	0.11	[-]	k_m	0.70	[-]	$l_{ef,y}$	3536.10	[mm]
$\sigma_{my,crit}$	48.12	[N/mm ²]	$\lambda_{rel,my}$	0.71	[-]	$k_{crit,y}$	1.00	[-]

TOETSING DOORBUIGING

Stf	Soort	l_{sys} [mm]	Overstek i j	BC Sit	u_{bij} [mm]	Toelaatbaar [mm]	$u_{fin,net}$ [mm]	Toelaatbaar [mm]
1	Dak	3549	Nee Nee	5 1	-0.1	-14.2	0.004	-0.3
2	Dak	3549	Nee Nee	5 1	-0.1	-14.2	0.004	-0.3

TOETSING DOORBUIGING (vervolg)

Stf	Soort	l_{sys} [mm]	Overstek i j	BC Sit	u_{inst} [mm]	Toelaatbaar [mm]
1	Dak	3549	Nee Nee	4 1	-0.2	-14.2
2	Dak	3549	Nee Nee	3 1	-0.2	-14.2

3.4 Houten balklaag zoldervloer

Algemene gegevens

Overspanning	3,90	m
H.o.h. afstand	610	mm
Dikte beplanking	18	mm
Gevolgklasse	CC 1	
Ontwerp levensduur	50	jaar
Houtsterkteklasse	C24	
Klimaatklasse	1	
Belastingduurklasse	III	(middellang)

Balkafmetingen

Breedte	71	mm
Hoogte	196	mm
W_y	455×10^3	mm^3
I_y	4455×10^4	mm^4
i_y	56,6	mm
W_z	165×10^3	mm^3
I_z	585×10^4	mm^4
i_z	20,5	mm

Belastingen

G: Eigen gewicht	$G_{k,i}$	0,50	kN/m^2
Q: Personen e.d.	$Q_{k,1}$	2,25	kN/m^2
	Ψ_2	0,30	
Q: Puntlast (0,10*0,10m ²)	$Q_{k,2}$	3,00	kN

Belastingfactor:

	$Y_{G,i}$	$Y_{Q,i}$
Fund. comb. 1	1,08	1,35

Materiaalgrootheden

	(-k)	(-d)	
$f_{m,0}$	24	14,77	N/mm^2
r_o	350	-	kg/m^3
$E_{0,mean}$	11000	-	N/mm^2
$E_{0,ser:beplanking}$	11000	-	N/mm^2
$f_{v,0}$	2,5	1,54	N/mm^2
Y_m	1,30	$g_{m,ser:d}$	1,00
$K_{mod,d}$	0,80	$K_{mod,ft}$	0,75
Y_{krp}	1,00	y_t	1,00 (Qe)
K_h	1,00		

K_{def}	0,60
y_r	0,77 (Fe)

Belastinggevallen

belastinggeval	Q_k (kN/m)	Q_d (kN/m)	F_k (kN)	F_d (kN)	M_{Ed} (kNm)	V_{Ed} (kN)	w_{inst} (mm)
G: Eigen gewicht	0,31	0,33	-	-	0,63	0,64	1,87
Q: Personen e.d.	1,37	1,85	-	-	3,52	3,61	8,44
Q: Puntlast	-	-	2,31	3,12	3,04	3,12	5,83

Belastingcombinaties

Belastingcombinatie	M_{Ed} (kNm)	V_{Ed} (kN)	w_{inst} (mm)	w_{bijk} (mm)	w_{fin} (mm)
Permanent + personen	4,15	4,26	1,87	11,08	12,95
Permanent + puntlast	3,67	3,76	1,87	6,95	8,83

Toetsing NEN-EN 1995 art. 6.3.3

maatgevend moment	M_{Ed}	4,15	kNm		
buigspanning	$S_{m,0,d}$	9,13	N/mm^2	u.c.	0,62
buigsterkte	$f_{m,0,u,d}$	14,77	N/mm^2		
maatgevende dwarskracht	V_{Ed}	4,26	kN		
schuifspanning	$S_{v,0,d}$	0,31	N/mm^2	u.c.	0,20
schuifsterkte	$f_{v,u,d}$	1,54	N/mm^2		

Toetsing NEN-EN 1995 art. 7.2

Maatgevende doorbuiging	w_{fin}	12,95		u.c.	0,83
	$w_{fin,max}$	15,60			
	w_{bijk}	11,08		u.c.	0,95
	$w_{bijk,max}$	11,70			

Toepassen balklaag: 71 x 196 h.o.h. 610

ULS u.c.:	0,62
SLS u.c.:	0,95

3.5 Stalen liggers t.b.v. kap + vliering

Belastingen	breedte (m)	factor	G _k (kN/m ²)	Q _k (kN/m ²)	ψ ₀	q _{g,k} (kN/m ¹)	q _{o,k} (kN/m ¹)
Dakconstructie	2,00	100%	1,13	0,09	0,00	2,27	0,00
Zoldervloer	1,95	100%	0,50	2,25	1,00	0,98	4,39
						3,24	4,39

F_{perm.}; Houten topspant = 3,54 kN

F_{ver.}; Houten topspant = 0,48 kN

Rechterzijgevel:

TS/Liggers

Rel: 6.10 20 jan 2016

Project.....: 14300 - Plan Bull-Tabaksveld te Puiflijk
 Onderdeel....: Stalen ligger t.b.v. kap + vliering (Rechterzijgevel)
 Constructeur.: ing. D. Anzion
 Opdrachtgever: Bouwbedrijf Schot
 Dimensies....: kN/m/rad
 Datum.....: 19/01/2016
 Bestand.....: p:\14300\algemeen\constabiel\statische berekening\prunus\stalen ligger t.b.v. kap + vliering (rechterzijgevel).dlw

Betrouwbaarheidsklasse : 1 Referentieperiode : 50

Toegepaste normen volgens Eurocode met Nederlandse NB

Belastingen	NEN-EN 1990:2002	C2:2010	NB:2011(nl)
	NEN-EN 1991-1-1:2002	C1:2009	NB:2011(nl)
Staal	NEN-EN 1993-1-1:2006	C2:2009	NB:2011(nl)

GEOMETRIE

Ligger:1

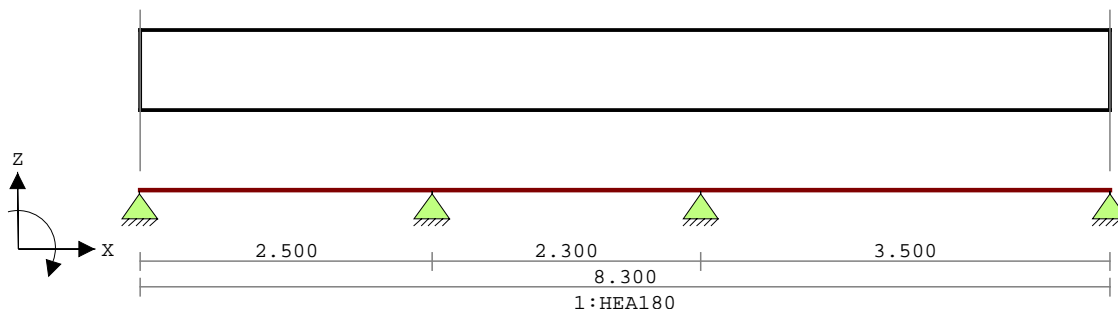

VELDLENGHTEN

Ligger:1

Veld	Vanaf	Tot	Lengte
1	0.000	2.500	2.500
2	2.500	4.800	2.300
3	4.800	8.300	3.500

MATERIALEN

Mt	Omschrijving	E-modulus[N/mm ²]	S.M.	Pois.	Uitz. coëff
1	S235	210000	78.5	0.30	1.2000e-005

PROFIELEN [mm]

Prof.	Omschrijving	Materiaal	Oppervlak	Traagheid	Vormf.
1	HEA180	1:S235	4.5300e+003	2.5100e+007	0.00

PROFIELEN vervolg [mm]

Prof.	Staaftype	Breedte	Hoogte	e	Type	b1	h1	b2	h2
1	0:Normaal	180	171	85.5					

DOORSNEDEN

Ligger:1

sector	Vanaf	Tot	Lengte	Profiel begin	z-begin	Profiel eind	z-eind
1	0.000	8.300	8.300	1:HEA180	0.000	1:HEA180	0.000

sector	Vanaf	Tot	Lengte	Eindcode	Bedding	Br.[mm]
1	0.000	8.300	8.300	1:Vast		

BELASTINGGEVALLEN

B.G.	Omschrijving	Belast/onbelast	ψ_0	ψ_1	ψ_2	e.g.
1	Permanent	2:Permanent EN1991				-1.00
2	Veranderlijk	1:Schaakbord EN1991	0.40	0.50	0.30	0.00

BELASTINGGEVALLEN

B.G.	Omschrijving	Type
1	Permanent	1 Permanente belasting
2	Veranderlijk	2 Ver. bel. pers. ed. (p_rep)

VELDBELASTINGEN

Ligger:1 B.G:1 Permanent

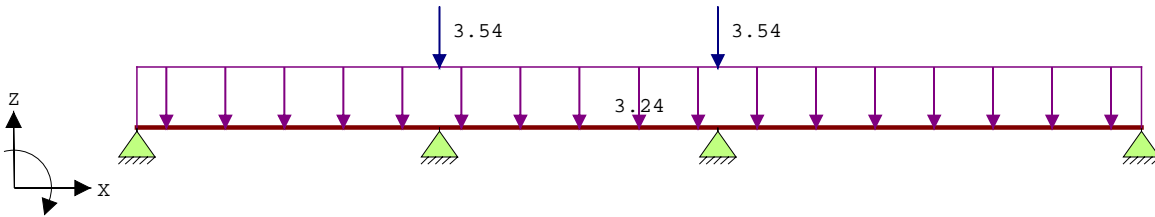

VELDBELASTINGEN

Ligger:1 B.G:1 Permanent

Last Ref.	Type	Omschrijving	q1/p/m	q2	psi	Afstand	Lengte
1	1:q-last		-3.240	-3.240		0.000	8.300
2	8:Puntlast			-3.540		2.500	
3	8:Puntlast			-3.540		4.800	

VERPLAATSINGEN [mm]

Ligger:1 B.G:1 Permanent

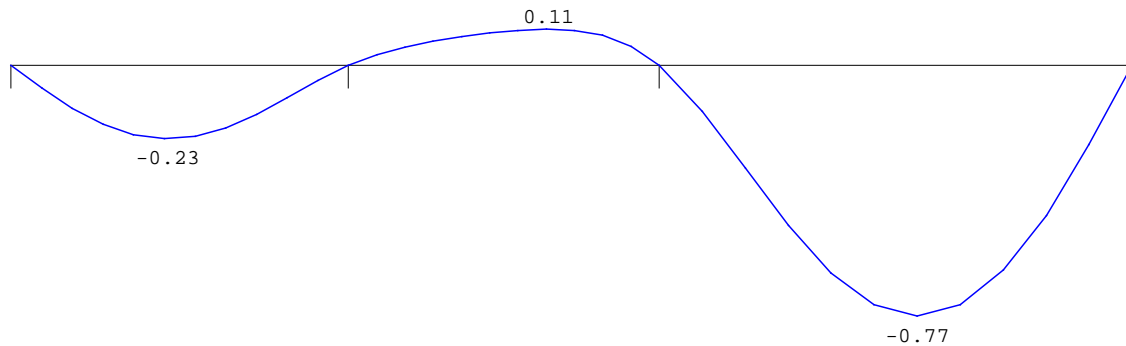

REACTIES

Ligger:1 B.G:1 Permanent

Stp	F	M
1	3.83	0.00
2	11.84	0.00
3	16.08	0.00
4	5.17	0.00

36.92 : (absoluut) grootste som reacties
 -36.92 : (absoluut) grootste som belastingen

VELDBELASTINGEN

Ligger:1 B.G:2 Veranderlijk

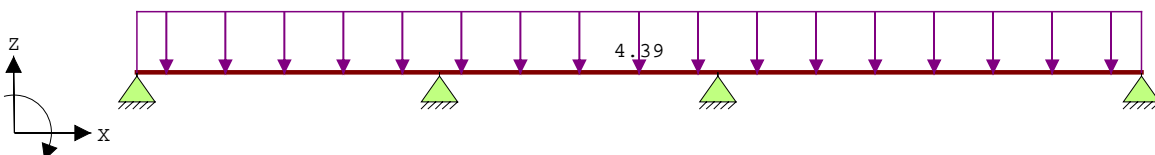

VELDBELASTINGEN

Ligger:1 B.G:2 Veranderlijk

Last Ref.	Type	Omschrijving	q1/p/m	q2	psi	Afstand	Lengte
1	1:q-last		-4.390	-4.390		0.000	8.300

VERPLAATSINGEN [mm]

Ligger:1 B.G:2 Veranderlijk

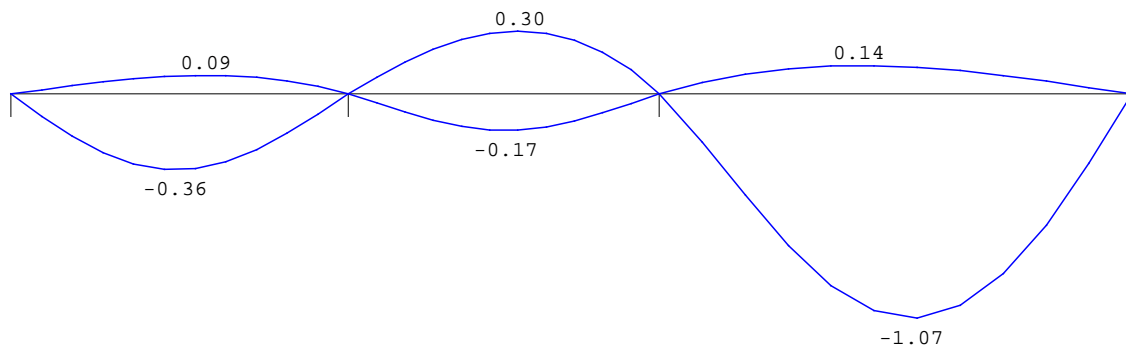

REACTIES

Ligger:1 B.G:2 Veranderlijk

Stp	Fmin	Fmax	Mmin	Mmax
1	-0.47	5.15	0.00	0.00
2	0.00	12.84	0.00	0.00
3	0.00	16.40	0.00	0.00
4	-0.26	6.57	0.00	0.00

BELASTINGCOMBINATIES

BC Type	BG Gen. Factor	BG Gen. Factor	BG Gen. Factor	BG Gen. Factor
1 Fund.	1 Perm	1.22		
2 Fund.	1 Perm	0.90		
3 Fund.	1 Perm	1.22	2 psi0	1.35
4 Fund.	1 Perm	1.08	2 Extr	1.35
5 Fund.	1 Perm	0.90	2 Extr	1.35
6 Fund.	1 Perm	0.90	2 psi0	1.35
7 Kar.	1 Perm	1.00	2 Extr	1.00
8 Quas.	1 Perm	1.00		
9 Quas.	1 Perm	1.00	2 psi2	1.00
10 Freq.	1 Perm	1.00		
11 Freq.	1 Perm	1.00	2 psi1	1.00
12 Blij.	1 Perm	1.00		

GUNSTIGE WERKING PERMANENTE BELASTINGEN

BC Velden met gunstige werking

- 1 Geen
- 2 Alle velden de factor:0.90
- 3 Geen
- 4 Geen
- 5 Alle velden de factor:0.90
- 6 Alle velden de factor:0.90

OMHULLENDE VAN DE FUNDAMENTELE COMBINATIES

MOMENTEN

Ligger:1 Fundamentele combinatie

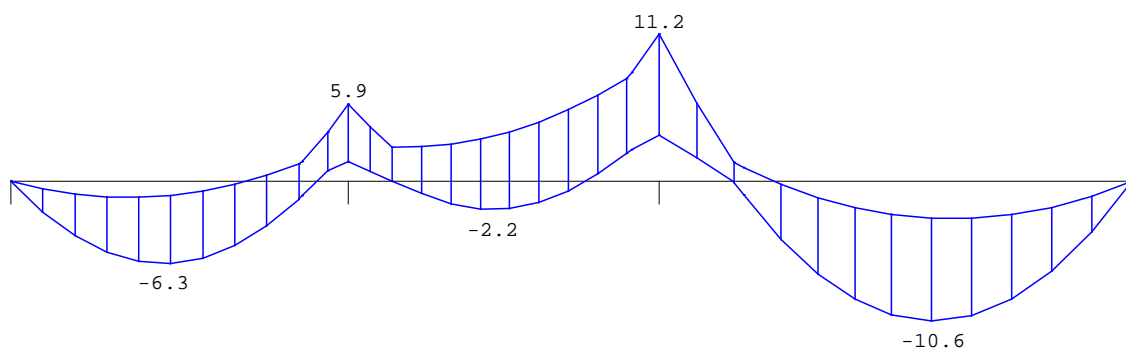

DWARSKRACHTEN

Ligger:1 Fundamentele combinatie

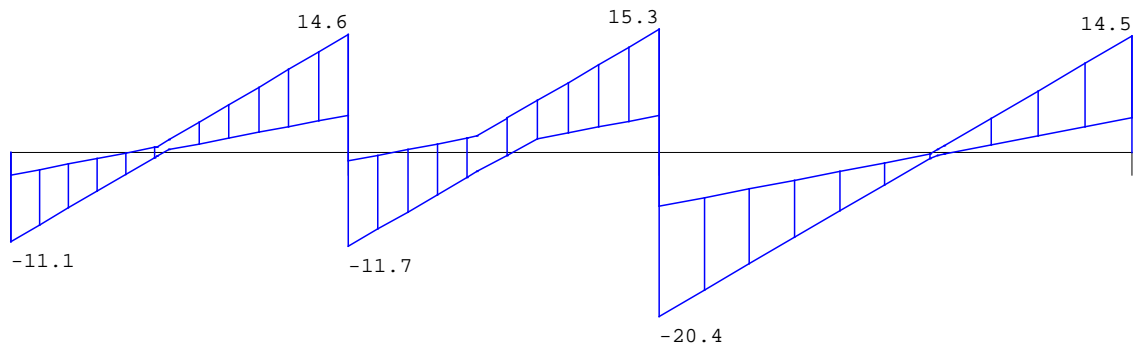

Fmin:2.82	10.7	14.5	4.30
Fmax:11.1	30.1	39.5	14.5

VELDWAARDEN

Ligger:1 Fundamentele combinatie

Veld	Pos.	Verpl. [mm]		Dwarskr		Moment	
		min.	max.	min.	max.	min.	max.
1	0.000	0.00	0.00	-11.08	-2.82	0.00	0.00
1	0.870				0.00		-1.22
1	0.965		-0.09				
1	1.130					-6.26	
1	1.134			0.00			
1	1.201	-0.73					
1	1.740						-0.00
1	2.269					-0.00	
1	2.327		0.01				
1	2.500	0.00	-0.00	4.64	14.62	1.49	5.90
2	0.000	0.00	0.00	-11.68	-1.05	1.49	5.90
2	0.325				0.00		
2	0.326					-0.00	
2	0.416						2.61
2	1.069					-2.16	
2	1.074	-0.14					
2	1.213			0.00			
2	1.311		0.52				
2	1.756					-0.00	
2	2.256	0.00					
2	2.300	-0.00	0.00	4.61	15.30	3.54	11.24
3	0.000	0.00	0.00	-20.38	-6.68	3.54	11.24
3	0.548					-0.00	
3	0.845						-0.00
3	1.883	-2.27					
3	2.008		-0.52				
3	2.024				0.00		
3	2.027					-10.65	
3	2.172			0.00			-2.85
3	3.500	0.00	-0.00	4.30	14.45	-0.00	0.00

REACTIES

Ligger:1 Fundamentele combinatie

Stp	Fmin	Fmax	Mmin	Mmax
1	2.82	11.08	0.00	0.00
2	10.66	30.13	0.00	0.00
3	14.47	39.50	0.00	0.00
4	4.30	14.45	0.00	0.00

OMHULLENDE VAN DE KARAKTERISTIEKE COMBINATIES

VERPLAATSINGEN [mm]

Ligger:1 Karakteristieke combinatie

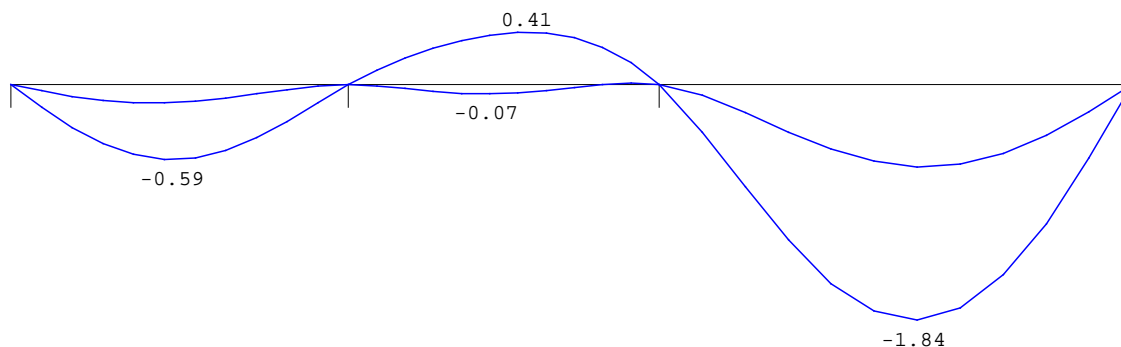

STAALPROFIELEN - ALGEMENE GEGEVENS

Ligger:1

Stabiliteit: Classificatie gehele constructie:

Geschoord

MATERIAAL

Mat nr.	Profielnaam	Vloeispl. [N/mm ²]	Productie methode	Min. drsn. klasse
1	HEA180	235	Gewalst	1

Partiële veiligheidsfactoren:
 Gamma M;0 : 1.00 Gamma M;1 : 1.00

KIPSTABILITEIT

Ligger:1

Staaflr.	Plts. aangr.	l gaffel	Kipsteunafstanden [m]	
1	1.0*h	boven:	2.50	2.500
		onder:	2.50	2.500
2	1.0*h	boven:	2.30	2.300
		onder:	2.30	2.300
3	1.0*h	boven:	3.50	3.500
		onder:	3.50	3.500

TOETSING SPANNINGEN

Ligger:1

Staaflr.	Mat nr.	BC	Sit	Kl	Plaats	Norm	Artikel	Formule	Hoogste toetsing U.C. [N/mm ²]	Opm.
1	1	4	2	1	My-max	EN3-1-1	6.2.5	(6.12y)	0.082	19
2	1	4	5	1	Einde	EN3-1-1	6.2.8	(6.30)	0.147	35
3	1	4	5	1	Begin	EN3-1-1	6.2.8	(6.30)	0.147	35

TOETSING DOORBUIGING

Ligger:1

Staaflr.	Soort	Mtg	Lengte [m]	Overst I	Overst J	Zeeg [mm]	u _{tot} [mm]	BC	Sit	u [mm]	Toelaatbaar [mm]	*1
1	Vloer	db	2.50	N	N	0.0	-0.6	7	2 Eind	-0.6	±10.0	0.004
									2 Bijk	-0.4	±7.5	0.003
2	Vloer	db	2.30	N	N	0.0	0.4	7	2 Eind	0.4	±9.2	0.004
									3 Eind	-0.1		
3	Vloer	db	3.50	N	N	0.0	-1.8	7	2 Bijk	0.3	±6.9	0.003
									2 Eind	-1.8	±14.0	0.004
		db						7	2 Bijk	-1.1	±10.5	0.003

Linkerzijgevel:

TS/Liggers

Rel: 6.10 20 jan 2016

Project.....: 14300 - Plan Bull-Tabaksveld te Puiflijk
 Onderdeel....: Stalen ligger t.b.v. kap + vliering (Linkerzijgevel)
 Constructeur.: ing. D. Anzion
 Opdrachtgever: Bouwbedrijf Schot
 Dimensies....: kN/m/rad
 Datum.....: 19/01/2016
 Bestand.....: p:\14300\algemeen\constabiel\statische berekening\prunus\stalen ligger
 t.b.v. kap + vliering (linkerzijgevel).dlw

Betrouwbaarheidsklasse : 1 Referentieperiode : 50

Toegepaste normen volgens Eurocode met Nederlandse NB

Belastingen	NEN-EN 1990:2002	C2:2010	NB:2011(nl)
	NEN-EN 1991-1-1:2002	C1:2009	NB:2011(nl)
Staal	NEN-EN 1993-1-1:2006	C2:2009	NB:2011(nl)

GEOMETRIE

Ligger:1

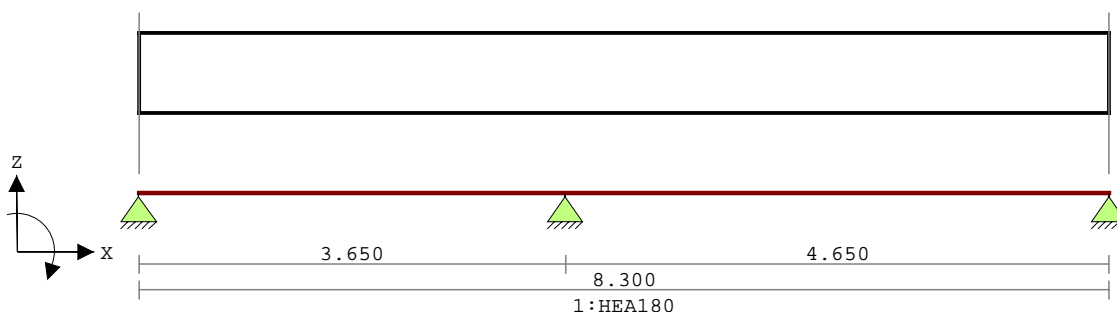

VELDLONGTEN

Ligger:1

Veld	Vanaf	Tot	Lengte
1	0.000	3.650	3.650
2	3.650	8.300	4.650

MATERIALEN

Mt	Omschrijving	E-modulus[N/mm ²]	S.M.	Pois.	Uitz. coëff
1	S235	210000	78.5	0.30	1.2000e-005

PROFIELEN [mm]

Prof.	Omschrijving	Materiaal	Oppervlak	Traagheid	Vormf.
1	HEA180	1:S235	4.5300e+003	2.5100e+007	0.00

PROFIELEN vervolg [mm]

Prof.	Staaftype	Breedte	Hoogte	e	Type	b1	h1	b2	h2
1	0:Normaal	180	171	85.5					

DOORSNEDEN

Ligger:1

sector	Vanaf	Tot	Lengte	Profiel begin	z-begin	Profiel eind	z-eind
1	0.000	8.300	8.300	1:HEA180	0.000	1:HEA180	0.000

sector	Vanaf	Tot	Lengte	Eindcode	Bedding	Br.[mm]
1	0.000	8.300	8.300	1:Vast		

BELASTINGGEVALLEN

B.G.	Omschrijving	Belast/onbelast	Ψ_0	Ψ_1	Ψ_2	e.g.
1	Permanent	2:Permanent EN1991				-1.00
2	Veranderlijk	1:Schaakbord EN1991	0.40	0.50	0.30	0.00

BELASTINGGEVALLEN

B.G.	Omschrijving	Type
1	Permanent	1 Permanente belasting
2	Veranderlijk	2 Ver. bel. pers. ed. (p_rep)

VELDBELASTINGEN

Ligger:1 B.G:1 Permanent

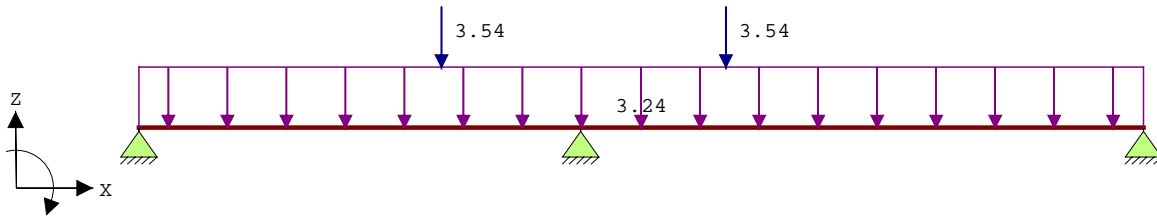

VELDBELASTINGEN

Ligger:1 B.G:1 Permanent

Last Ref.	Type	Omschrijving	q1/p/m	q2	psi	Afstand	Lengte
1	1:q-last		-3.240	-3.240		0.000	8.300
2	8:Puntlast		-3.540			2.500	
3	8:Puntlast		-3.540			4.850	

VERPLAATSINGEN [mm]

Ligger:1 B.G:1 Permanent

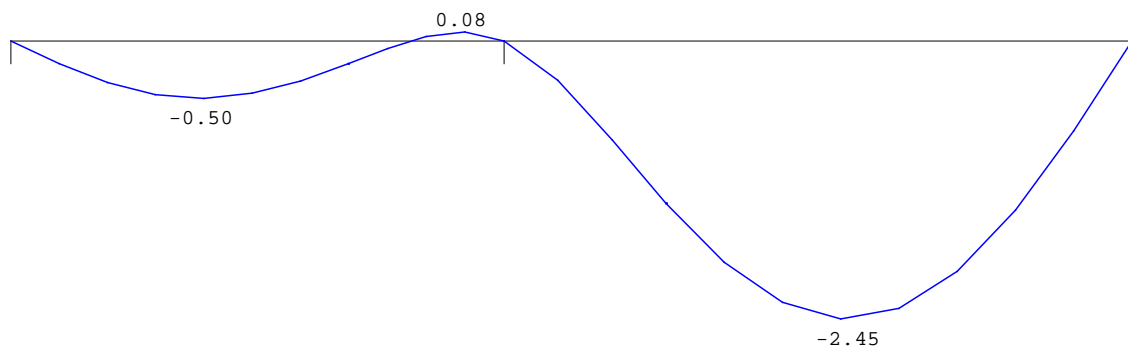

REACTIES

Ligger:1 B.G:1 Permanent

Stp	F	M
1	4.76	0.00
2	25.18	0.00
3	6.98	0.00

36.92 : (absoluut) grootste som reacties
 -36.92 : (absoluut) grootste som belastingen

VELDBELASTINGEN

Ligger:1 B.G:2 Veranderlijk

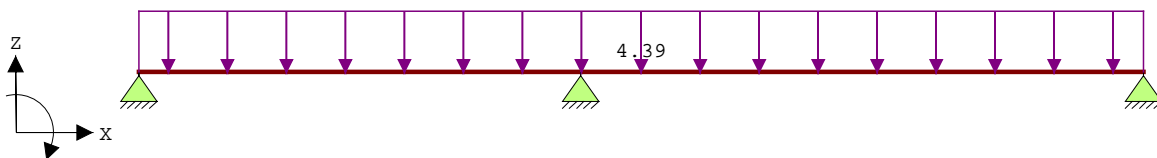

VELDBELASTINGEN

Ligger:1 B.G:2 Veranderlijk

Last Ref.	Type	Omschrijving	q1/p/m	q2	psi	Afstand	Lengte
1	1:q-last		-4.390	-4.390		0.000	8.300

VERPLAATSINGEN [mm]

Ligger:1 B.G:2 Veranderlijk

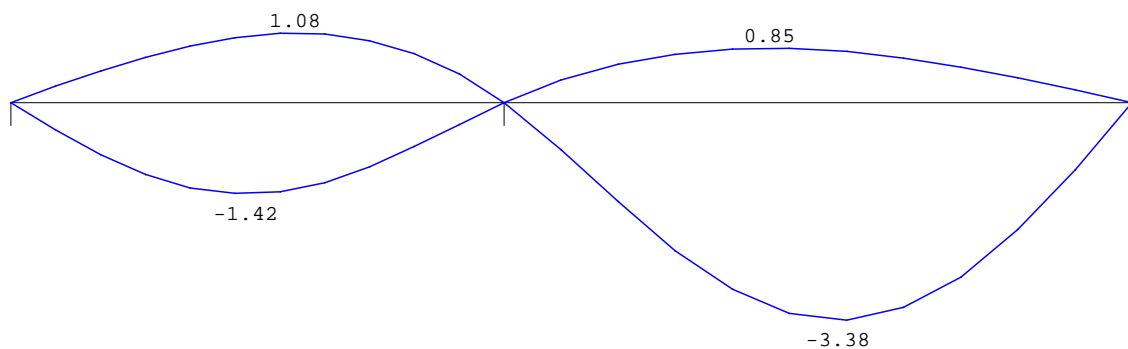

REACTIES

Ligger:1 B.G:2 Veranderlijk

Stp	Fmin	Fmax	Mmin	Mmax
1	-1.82	7.13	0.00	0.00
2	0.00	23.04	0.00	0.00
3	-0.69	8.78	0.00	0.00

BELASTINGCOMBINATIES

BC Type	BG Gen.	Factor	BG Gen.	Factor	BG Gen.	Factor	BG Gen.	Factor
1 Fund.	1 Perm	1.22						
2 Fund.	1 Perm	0.90						
3 Fund.	1 Perm	1.22	2 psi0	1.35				
4 Fund.	1 Perm	1.08	2 Extr	1.35				
5 Fund.	1 Perm	0.90	2 Extr	1.35				
6 Fund.	1 Perm	0.90	2 psi0	1.35				
7 Kar.	1 Perm	1.00	2 Extr	1.00				
8 Quas.	1 Perm	1.00						
9 Quas.	1 Perm	1.00	2 psi2	1.00				
10 Freq.	1 Perm	1.00						
11 Freq.	1 Perm	1.00	2 psi1	1.00				
12 Blij.	1 Perm	1.00						

GUNSTIGE WERKING PERMANENTE BELASTINGEN

BC Velden met gunstige werking

- 1 Geen
- 2 Alle velden de factor:0.90
- 3 Geen
- 4 Geen
- 5 Alle velden de factor:0.90
- 6 Alle velden de factor:0.90

OMHULLENDE VAN DE FUNDAMENTELE COMBINATIES

MOMENTEN

Ligger:1 Fundamentele combinatie

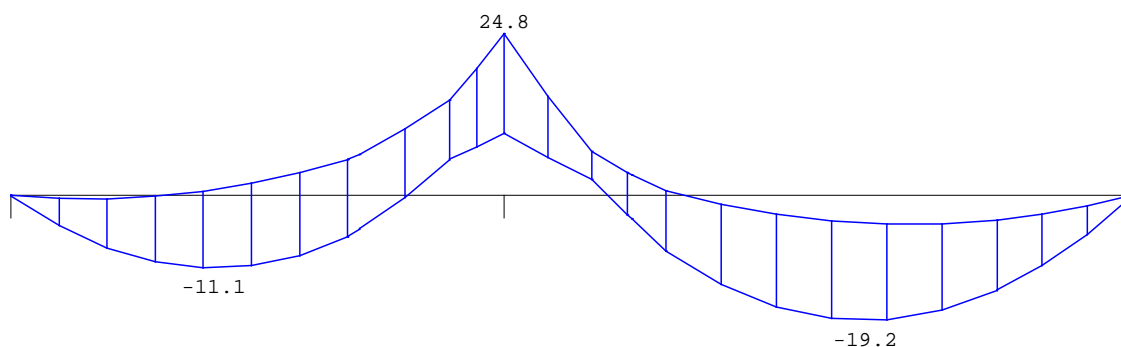

DWARSKRACHTEN

Ligger:1 Fundamentele combinatie

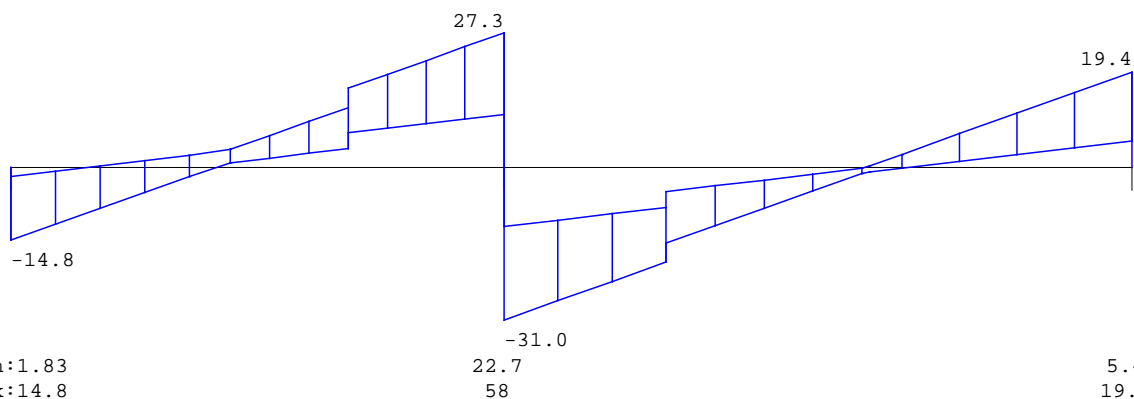

VELDWAARDEN

Ligger:1 Fundamentele combinatie

Veld	Pos.	Verpl. [mm]		Dwarskr		Moment	
		min.	max.	min.	max.	min.	max.
1	0.000	0.00	0.00	-14.77	-1.83	0.00	0.00
1	0.564				0.00		-0.51
1	1.128						-0.00
1	1.505					-11.12	
1	1.518			0.00			
1	1.640	-2.44					
1	2.500		1.20				
1	2.934					-0.00	
1	3.650	-0.00	0.00	10.71	27.32	9.58	24.81
2	0.000	0.00	0.00	-30.98	-11.95	9.58	24.81
2	0.359		0.13				
2	0.769					-0.00	
2	1.343						-0.00
2	2.501	-7.21					
2	2.671				0.00		
2	2.673					-19.17	
2	2.848		-1.17				
2	2.996			0.00			-4.43
2	4.650	0.00	-0.00	5.35	19.39	-0.00	0.00

REACTIES

Ligger:1 Fundamentele combinatie

Stp	Fmin	Fmax	Mmin	Mmax
1	1.83	14.77	0.00	0.00
2	22.66	58.30	0.00	0.00
3	5.35	19.39	0.00	0.00

OMHULLENDE VAN DE KARAKTERISTIEKE COMBINATIES

VERPLAATSINGEN [mm]

Ligger:1 Karakteristieke combinatie

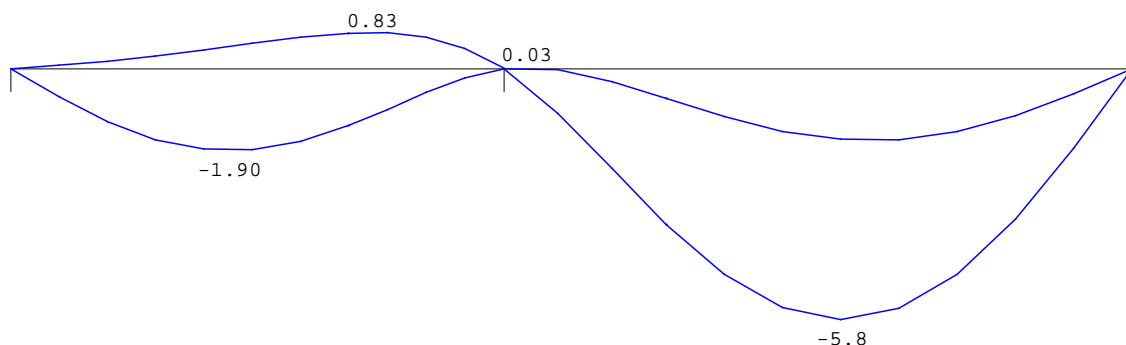

STAALPROFIELEN - ALGEMENE GEGEVENS

Ligger:1

Stabiliteit: Classificatie gehele constructie: Geschoord

MATERIAAL

Mat nr.	Profielnaam	Vloeisp. [N/mm ²]	Productie methode	Min. drsn. klasse
1	HEA180	235	Gewalst	1

Partiële veiligheidsfactoren:
Gamma M;0 : 1.00 Gamma M;1 : 1.00

KIPSTABILITEIT

Ligger:1

Staaft	Plts. aangr.	1 gaffel	Kipsteunafstanden [m]
1	1.0*h	boven:	3.65 3.650
		onder:	3.65 3.650
2	1.0*h	boven:	4.65 4.650
		onder:	4.65 4.650

TOETSING SPANNINGEN

Ligger:1

Staaft Mat BC Sit Kl Plaats Norm Artikel Formule Hoogste toetsing Opm.
nr. U.C. [N/mm²]

Staaft nr.	Mat	BC	Sit	Kl	Plaats	Norm	Artikel	Formule	Hoogste toetsing U.C. [N/mm ²]	Opm.
1	1	4	1	1	Einde	EN3-1-1	6.2.8	(6.30)	0.325	76 46
2	1	4	1	1	Staaft	EN3-1-1	6.3.2	(6.54)	0.366	86 46

Opmerkingen:

[46] T.b.v. kip is een equivalente Q-last berekend.

TOETSING DOORBUIGING

Ligger:1

Staaft	Soort	Mtg	Lengte [m]	Overst I	Overst J	Zeeg [mm]	u _{tot} [mm]	BC	Sit	u [mm]	Toelaatbaar [mm]	*1	
1	Vloer	db	3.65	N	N	0.0	-1.9	7	2	Eind	-1.9	±14.6	0.004
		db								Bijk	-1.4	±10.9	0.003
2	Vloer	db	4.65	N	N	0.0	-5.8	7	3	Eind	-5.8	±18.6	0.004
		db								Bijk	-3.4	±13.9	0.003

3.6 Stalen ligger in rechterzijgevel t.p.v. de woonkamer

Belastingen	breedte (m)	factor	G_k (kN/m ²)	Q_k (kN/m ²)	ψ_0	$q_{q,k}$ (kN/m ¹)	$q_{o,k}$ (kN/m ¹)
Dakconstructie	1,00	100%	1,13	0,09	0,00	1,13	0,00
Verdiepingsvloer	2,70	100%	5,00	2,55	1,00	13,50	6,89
Gevel / wand	1,50	100%	2,00	0,00	0,00	3,00	0,00
						17,63	6,89

TS/Liggers

Rel: 6.10 20 jan 2016

Project.....: 14300 - Plan Bull-Tabaksveld te Puiflijk
 Onderdeel....: Stalen ligger in rechterzijgevel t.p.v. de woonkamer
 Constructeur.: ing. D. Anzion
 Opdrachtgever: Bouwbedrijf Schot
 Dimensies....: kN/m/rad
 Datum.....: 19/01/2016
 Bestand.....: p:\14300\algemeen\constabiel\statische berekening\prunus\stalen ligger in
 rechterzijgevel t.p.v. de woonkamer.dlw

Betrouwbaarheidsklasse : 1 Referentieperiode : 50

Toegepaste normen volgens Eurocode met Nederlandse NB

Belastingen	NEN-EN 1990:2002	C2:2010	NB:2011(nl)
	NEN-EN 1991-1-1:2002	C1:2009	NB:2011(nl)
Staal	NEN-EN 1993-1-1:2006	C2:2009	NB:2011(nl)

GEOMETRIE

Ligger:1

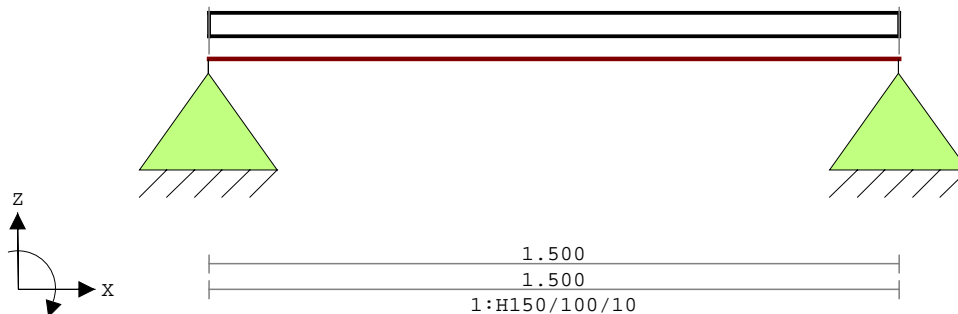

VELDLENGTEN

Ligger:1

Veld	Vanaf	Tot	Lengte
1	0.000	1.500	1.500

MATERIALEN

Mt	Omschrijving	E-modulus[N/mm ²]	S.M.	Pois.	Uitz. coëff
1	S235	210000	78.5	0.30	1.2000e-005

PROFIELEN [mm]

Prof.	Omschrijving	Materiaal	Oppervlak	Traagheid	Vormf.
1	H150/100/10	1:S235	2.4180e+003	5.5200e+006	0.00

PROFIELEN vervolg [mm]

Prof.	Staaftype	Breedte	Hoogte	e	Type	b1	h1	b2	h2
1	0:Normaal	100	150	48.0					

BELASTINGGEVALLEN

B.G.	Omschrijving	Belast/onbelast	ψ_0	ψ_1	ψ_2	e.g.
1	Permanent	2:Permanent EN1991				-1.00
2	Veranderlijk	1:Schaakbord EN1991	0.40	0.50	0.30	0.00

BELASTINGGEVALLEN

B.G.	Omschrijving	Type
1	Permanent	1 Permanente belasting
2	Veranderlijk	2 Ver. bel. pers. ed. (p_rep)

VELDBELASTINGEN

Ligger:1 B.G:1 Permanent

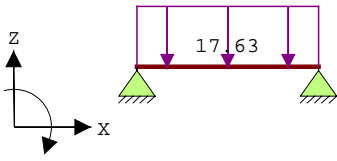

VELDBELASTINGEN

Ligger:1 B.G:1 Permanent

Last Ref.	Type	Omschrijving	q1/p/m	q2	psi	Afstand	Lengte
1	1:q-last		-17.630	-17.630	0.000	1.500	

VERPLAATSINGEN [mm]

Ligger:1 B.G:1 Permanent

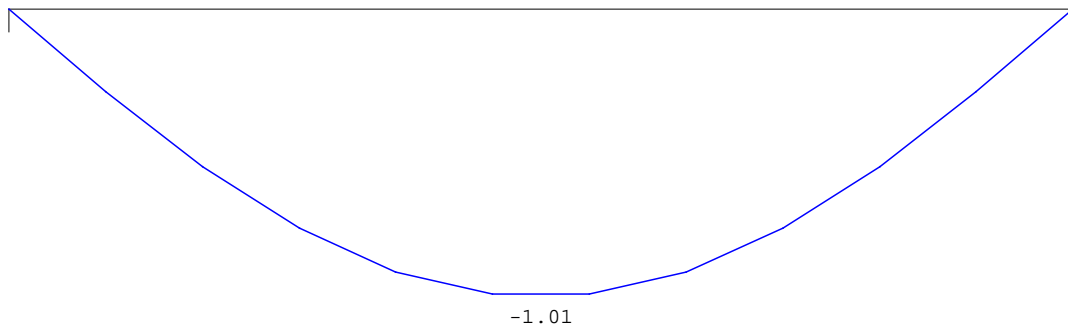

REACTIES

Ligger:1 B.G:1 Permanent

Stp	F	M
1	13.36	0.00
2	13.36	0.00

26.73 : (absoluut) grootste som reacties
 -26.73 : (absoluut) grootste som belastingen

VELDBELASTINGEN

Ligger:1 B.G:2 Veranderlijk

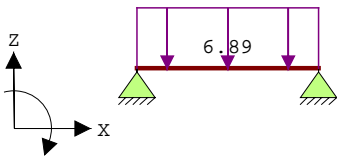

VELDBELASTINGEN

Ligger:1 B.G:2 Veranderlijk

Last Ref.	Type	Omschrijving	q1/p/m	q2	psi	Afstand	Lengte
1	1:q-last		-6.890	-6.890	0.000	1.500	

VERPLAATSINGEN [mm]

Ligger:1 B.G:2 Veranderlijk

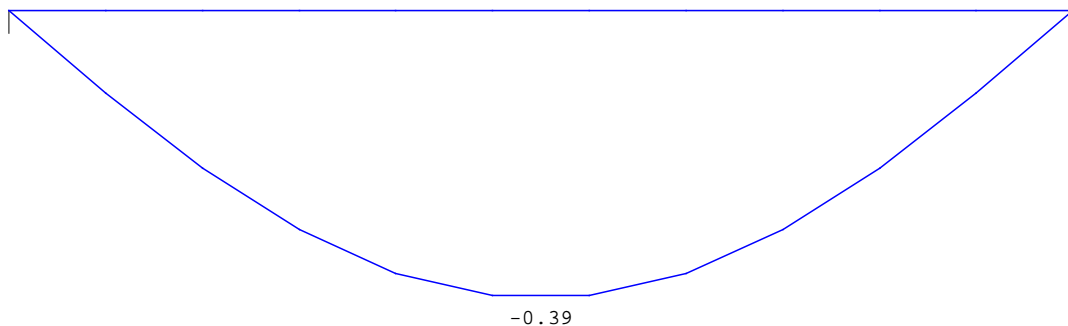

REACTIES

Ligger:1 B.G:2 Veranderlijk

Stp	Fmin	Fmax	Mmin	Mmax
1	0.00	5.17	0.00	0.00
2	0.00	5.17	0.00	0.00

OMHULLENDE VAN DE KARAKTERISTIEKE COMBINATIES

VERPLAATSINGEN [mm]

Ligger:1 Karakteristieke combinatie

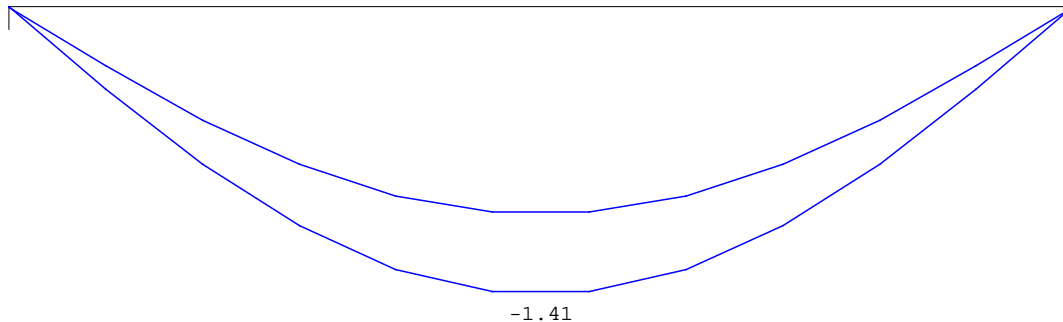

STAALPROFIELEN - ALGEMENE GEGEVENS

Ligger:1

Stabiliteit: Classificatie gehele constructie:

Geschoord

MATERIAAL

Mat nr.	Profielnaam	Vloeisp. [N/mm ²]	Productie methode	Min. drsn. klasse
1	H150/100/10	235	Gewalst	1

Partiële veiligheidsfactoren:
 Gamma M;0 : 1.00 Gamma M;1 : 1.00

KIPSTABILITEIT

Ligger:1

Staafl	Plts. aangr.	1 gaffel	Kipsteunafstanden [m]	
1	1.0*h	boven:	1.50	1.500
		onder:	1.50	1.500

TOETSING SPANNINGEN

Ligger:1

Staafl nr.	Mat nr.	BC	Sit	Kl	Plaats	Norm	Artikel	Formule	Hoogste toetsing U.C. [N/mm ²]	Opm.
1	1	4	1	3	My-max	EN3-1-1	6.2.5	(6.12y)	0.632	148 76

Opmerkingen:

[76] Toetsing van kipstabiliteit voor dit profieltype is niet voorzien.

TOETSING DOORBUIGING

Ligger:1

Staafl	Soort	Mtg	Lengte [m]	Overst I	Zeeg J	u _{tot} [mm]	BC	Sit	u [mm]	Toelaatbaar [mm]	*1
1	Vloer	db	1.50	N	N	0.0	7	1 Eind	-1.4	±6.0	0.004
		db					7	1 Bijk	-0.4	±4.5	0.003

3.7 Stalen ligger in rechterzijgevel t.p.v. de entree

Belastingen	breedte (m)	factor	G _k (kN/m ²)	Q _k (kN/m ²)	ψ ₀	q _{q,k} (kN/m ¹)	q _{o,k} (kN/m ¹)
Dakconstructie	1,00	100%	1,13	0,09	0,00	1,13	0,00
Verdiepingsvloer	2,70	100%	5,00	2,55	1,00	13,50	6,89
Gevel / wand	1,50	100%	2,00	0,00	0,00	3,00	0,00
						17,63	6,89

F_{perm.}; stalen ligger vliering + kap = 11,80 kN

F_{ver.}; stalen ligger vliering + kap = 12,80 kN

TS/Liggers

Rel: 6.10 20 jan 2016

Project.....: 14300 - Plan Bull-Tabaksveld te Puiflijk
 Onderdeel....: Stalen ligger in rechterzijgevel t.p.v. de entree
 Constructeur.: ing. D. Anzion
 Opdrachtgever: Bouwbedrijf Schot
 Dimensies....: kN/m/rad
 Datum.....: 19/01/2016
 Bestand.....: p:\14300\algemeen\constabiel\statische berekening\prunus\stalen ligger in rechterzijgevel t.p.v. de entree.dlw

Betrouwbaarheidsklasse : 1 Referentieperiode : 50

Toegepaste normen volgens Eurocode met Nederlandse NB

Belastingen	NEN-EN 1990:2002	C2:2010	NB:2011(nl)
	NEN-EN 1991-1-1:2002	C1:2009	NB:2011(nl)
Staal	NEN-EN 1993-1-1:2006	C2:2009	NB:2011(nl)

GEOMETRIE

Ligger:1

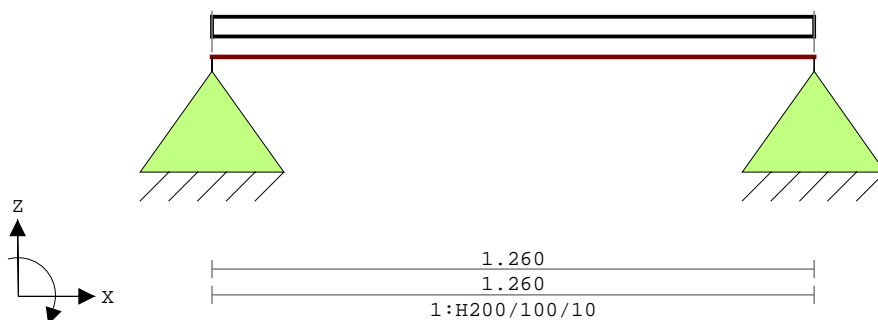

VELDLONGTEN

Ligger:1

Veld	Vanaf	Tot	Lengte
1	0.000	1.260	1.260

MATERIALEN

Mt	Omschrijving	E-modulus[N/mm ²]	S.M.	Pois.	Uitz. coëff
1	S235	210000	78.5	0.30	1.2000e-005

PROFIELEN [mm]

Prof.	Omschrijving	Materiaal	Oppervlak	Traagheid	Vormf.
1	H200/100/10	1:S235	2.9240e+003	1.2190e+007	0.00

PROFIELEN vervolg [mm]

Prof.	Staaftype	Breedte	Hoogte	e	Type	b1	h1	b2	h2
1	0:Normaal	100	200	69.3					

BELASTINGGEVALLEN

B.G.	Omschrijving	Belast/onbelast	ψ ₀	ψ ₁	ψ ₂	e.g.
1	Permanent	2:Permanent EN1991				-1.00
2	Veranderlijk	1:Schaakbord EN1991	0.40	0.50	0.30	0.00

BELASTINGGEVALLEN

B.G.	Omschrijving	Type
1	Permanent	1 Permanente belasting
2	Veranderlijk	2 Ver. bel. pers. ed. (p_rep)

VELDBELASTINGEN

Ligger:1 B.G:1 Permanent

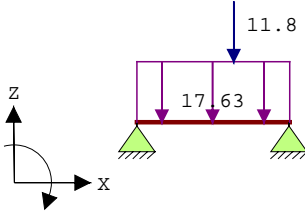

VELDBELASTINGEN

Ligger:1 B.G:1 Permanent

Last Ref.	Type	Omschrijving	q1/p/m	q2	psi	Afstand	Lengte
1	1:q-last		-17.630	-17.630		0.000	1.260
2	8:Puntlast		-11.800			0.800	

VERPLAATSINGEN [mm]

Ligger:1 B.G:1 Permanent

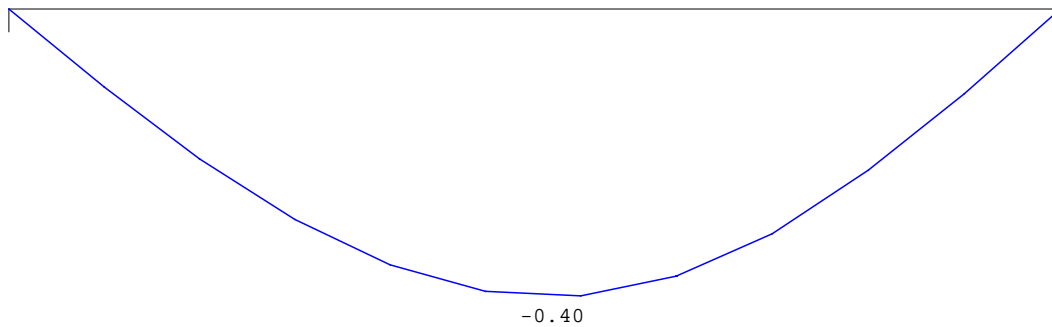

REACTIES

Ligger:1 B.G:1 Permanent

Stp	F	M
1	15.56	0.00
2	18.74	0.00

34.30 : (absoluut) grootste som reacties
 -34.30 : (absoluut) grootste som belastingen

VELDBELASTINGEN

Ligger:1 B.G:2 Veranderlijk

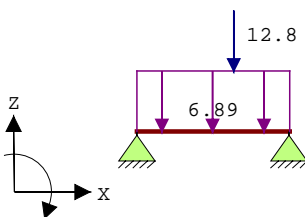

VELDBELASTINGEN

Ligger:1 B.G:2 Veranderlijk

Last Ref.	Type	Omschrijving	q1/p/m	q2	psi	Afstand	Lengte
1	1:q-last		-6.890	-6.890		0.000	1.260
2	8:Puntlast		-12.800			0.800	

VERPLAATSINGEN [mm]

Ligger:1 B.G:2 Veranderlijk

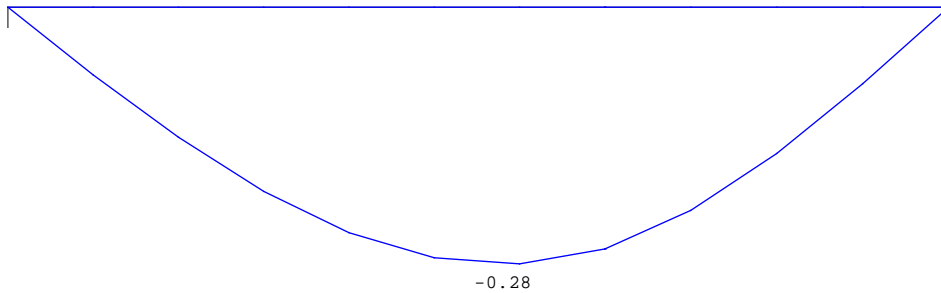

REACTIES

Ligger:1 B.G:2 Veranderlijk

Stp	Fmin	Fmax	Mmin	Mmax
1	0.00	9.01	0.00	0.00
2	0.00	12.47	0.00	0.00

BELASTINGCOMBINATIES

BC Type	BG Gen.	Factor	BG Gen.	Factor	BG Gen.	Factor	BG Gen.	Factor
1 Fund.	1 Perm	1.22						
2 Fund.	1 Perm	0.90						
3 Fund.	1 Perm	1.22	2 psi0	1.35				
4 Fund.	1 Perm	1.08	2 Extr	1.35				
5 Fund.	1 Perm	0.90	2 Extr	1.35				
6 Fund.	1 Perm	0.90	2 psi0	1.35				
7 Kar.	1 Perm	1.00	2 Extr	1.00				
8 Quas.	1 Perm	1.00						
9 Quas.	1 Perm	1.00	2 psi2	1.00				
10 Freq.	1 Perm	1.00						
11 Freq.	1 Perm	1.00	2 psi1	1.00				
12 Blij.	1 Perm	1.00						

GUNSTIGE WERKING PERMANENTE BELASTINGEN

BC Velden met gunstige werking

- 1 Geen
- 2 Alle velden de factor:0.90
- 3 Geen
- 4 Geen
- 5 Alle velden de factor:0.90
- 6 Alle velden de factor:0.90

OMHULLENDE VAN DE FUNDAMENTELE COMBINATIES

MOMENTEN

Ligger:1 Fundamentele combinatie

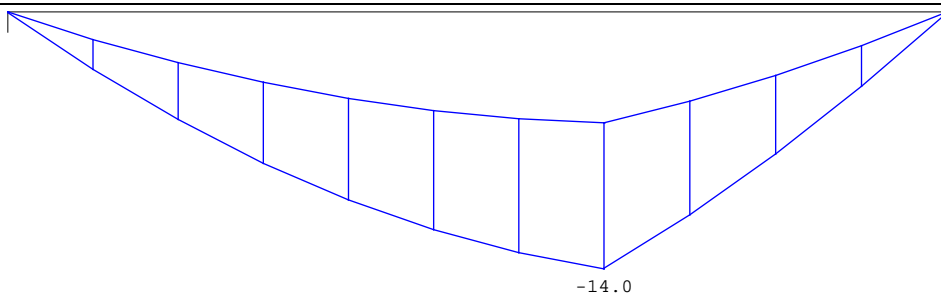

DWARSKRACHTEN

Ligger:1 Fundamentele combinatie

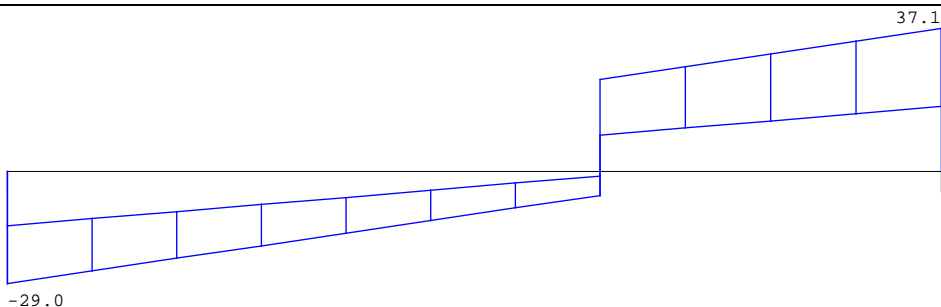

-29.0
Fmin:14.0
Fmax:29.0

37.1
16.9
37.1

VELDWAARDEN

Ligger:1 Fundamentele combinatie

Veld	Pos.	Verpl. [mm]		Dwarskr		Moment	
		min.	max.	min.	max.	min.	max.
1	0.000	0.00	0.00	-28.97	-14.00	0.00	0.00
1	0.651		-0.36				
1	0.657	-0.81					
1	0.800			-6.10	-1.14	-14.03	-6.06
1	0.800			9.48	23.92	-14.03	-6.06
1	1.260	0.00	-0.00	16.87	37.07	-0.00	0.00

REACTIES

Ligger:1 Fundamentele combinatie

Stp	Fmin	Fmax	Mmin	Mmax
1	14.00	28.97	0.00	0.00
2	16.87	37.07	0.00	0.00

OMHULLENDE VAN DE KARAKTERISTIEKE COMBINATIES

VERPLAATSINGEN [mm]

Ligger:1 Karakteristieke combinatie

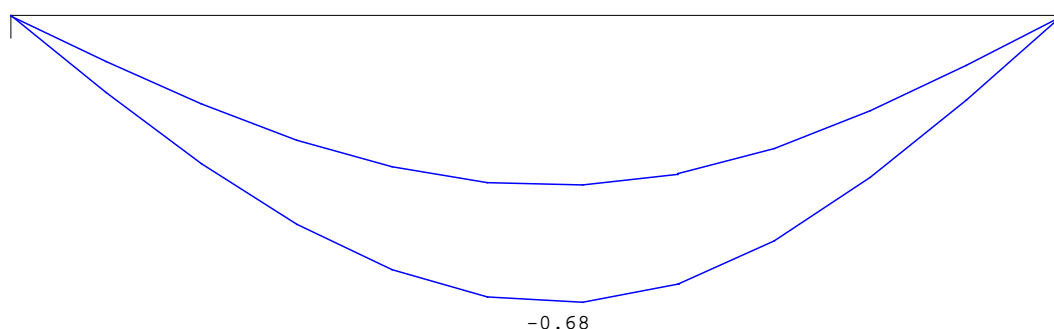

STAALPROFIELEN - ALGEMENE GEGEVENS

Ligger:1

Stabiliteit: Classificatie gehele constructie: Geschoord

MATERIAAL

Mat nr.	Profielnaam	Vloeisp. [N/mm ²]	Productie methode	Min. drsn. klasse
1	H200/100/10	235	Gewalst	1

Partiële veiligheidsfactoren:
Gamma M;0 : 1.00 Gamma M;1 : 1.00

KIPSTABILITEIT

Ligger:1

Staafl. nr.	Plts. aangr.	l gaffel	Kipsteunafstanden [m]
1	1.0*h	boven: onder:	1.26 1.260 1.26 1.260

TOETSING SPANNINGEN

Ligger:1

Staafl. nr.	Mat	BC	Sit	Kl	Plaats	Norm	Artikel	Formule	Hoogste toetsing U.C. [N/mm ²]	Opm.
1	1	4	1	4	My-max	EN3-1-1	6.2.8	(6.29)	0.832	151 76

Opmerkingen:

[76] Toetsing van kipstabiliteit voor dit profieltype is niet voorzien.

TOETSING DOORBUIGING

Ligger:1

Staafl. nr.	Soort	Mtg	Lengte [m]	Overst I	Zeeg J	Zeeg [mm]	u _{tot} [mm]	BC	Sit	u [mm]	Toelaatbaar [mm]	*1
1	Vloer	db	1.26	N	N	0.0	-0.7	7	1 Eind	-0.7	±5.0	0.004
		db						7	1 Bijk	-0.3	±3.8	0.003

3.8 Stabiliteit

Bepaling belastingen

Windfactoren dak	0,67	-0,20
Windfactoren gevel	0,80	-0,50
Reductiefactor	0,85	
q_p	0,53 kN/m ²	
dakhelling	55 °	
terreincategorie	III	
gebouwbreedte	6,0 m	
gebouwhoogte	9,1 m	
$c_s c_d$	0,92	conform tabel D.2 NEN-EN 1991-1-4

bouwlaag
lengte hoogte

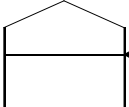
8,9	4,8		$F_w = 8,9 * 4,8 * 0,87 * 0,53 * 0,85 / \sin 55 * \sin 55 * 0,92 = 15,4 \text{ kN}$
8,9	1,5		$F_w = 8,9 * 1,3 * 1,30 * 0,53 * 0,85 * 0,92 = 6,23 \text{ kN}$
8,9	2,8		$F_w = 8,9 * 1,5 * 1,30 * 0,53 * 0,85 * 0,92 = 7,19 \text{ kN} +$ 28,8 kN

Opneembare belastingen penant A *Voorgevel*

Actief bij: wind van links

Afmetingen penant	t = 100 mm	Meewerkende flensbreedte	4300 / 5 = 860 mm
	h = 950 mm		2650 / 2 = 1325 mm
	l = 2650 mm		100 * 6 = 600 mm
			maatgevend = 600 mm

Bouwmuur t = 100 mm

Excentriciteit e van de belasting is de afstand tussen het aangrijpingspunt van de belasting en het einde van de penant

e = 475 mm

centrische belasting	breedte (m)	G_k (kN/m ²)	$q_{G,d}$ (kN/m ¹)
Gevel / wand	4,60	1,85	<u>7,66</u>
			7,66

Excentriciteit e van de belasting is de afstand tussen het aangrijpingspunt van de belasting en het einde van de penant

e = 900 mm

excentrische belasting	breedte (m)	lengte (m)	G_k (kN/m ²)	$F_{G,d}$ (kN)
Dakconstructie	0,00	0,00	1,13	0,00
Verdiepingsvloer	2,70	2,00	5,00	24,30
Gevel / wand	2,00	1,40	1,85	4,66
Gevel / wand	1,26	2,65	1,85	<u>5,57</u>
				34,53

Totale bovenbelasting = 41,81 kN

Excentriciteit totale belasting = 826 mm

Materiaalgegevens

materiaal	kalkzandsteen
hechting	lijmmortel
materiaalfactor	1,5
rekenwaarde druksterkte	$f_d = 4,41 \text{ N/mm}^2$
rekenwaarde afschuifsterkte	$f_{v,k,d} = 0,27 \text{ N/mm}^2$

Bepaling opneembaar moment

$\lambda_x =$	41809 / (0,643 * 4,41 * 100) =	147 mm
$e_u =$	826 - 0,354 * 147,5 =	774 mm
$M_u =$	0,774 * 41,81 =	32,4 kNm
$M_{Rd} =$	0,8 * 32,4 =	25,9 kNm

Bepaling opneembare dwarskracht

$V_{Ed} = 147,49 * 100 * 0,27 / 1000 + 41,8 * 0,4 = 20,7 \text{ kN}$

Opneembare belastingen penant B

Achtergevel

Actief bij: wind van links

Afmetingen penant	t = 100 mm	Meewerkende flensbreedte	4300 / 5 = 860 mm
	h = 730 mm		2650 / 2 = 1325 mm
	l = 2650 mm		100 * 6 = 600 mm
			maatgevend = 600 mm

Bouwmuur t = 100 mm

Excentriciteit e van de belasting is de afstand tussen het aangrijpingspunt van de belasting en het einde van de penant

e = 365 mm

centrische belasting	breedte (m)	G _k (kN/m ²)	q _{G,d} (kN/m ¹)
Gevel / wand	4,60	1,85	<u>7,66</u>
			7,66

Excentriciteit e van de belasting is de afstand tussen het aangrijpingspunt van de belasting en het einde van de penant

e = 680 mm

excentrische belasting	breedte (m)	lengte (m)	G _k (kN/m ²)	F _{G,d} (kN)
Dakconstructie	0,00	0,00	1,13	0,00
Verdiepingsvloer	2,70	2,00	5,00	24,30
Gevel / wand	2,00	1,40	1,85	4,66
Gevel / wand	1,26	2,65	1,85	<u>5,57</u>
				34,53

Totale bovenbelasting = 40,12 kN

Excentriciteit totale belasting = 636 mm

Materiaalgegevens

materiaal	kalkzandsteen
hechting	lijmmortel
materiaalfactor	1,5
rekenwaarde druksterkte	f _d = 4,41 N/mm ²
rekenwaarde afschuifsterkte	f _{v;k;d} = 0,27 N/mm ²

Bepaling opneembaar moment

λ _x =	40124 / (0,643 * 4,41 * 100) =	142 mm
e _u =	636 - 0,354 * 141,5 =	586 mm
M _u =	0,586 * 40,12 =	23,5 kNm
M _{Rd} =	0,8 * 23,5 =	18,8 kNm

Bepaling opneembare dwarskracht

V_{Ed} = 141,54 * 100 * 0,27 / 1000 + 40,1 * 0,4 = 19,8 kN

Opneembare belastingen penant C

Stabiliteitswand

Actief bij: wind van links

Afmetingen penant	t =	120 mm	Meewerkende flensbreedte	4300 / 5 =	860 mm
	h =	2380 mm		2650 / 2 =	1325 mm
	l =	2650 mm		120 * 6 =	720 mm
				maatgevend =	720 mm

Bouwmuur t = 120 mm

Excentriciteit e van de belasting is de afstand tussen het aangrijpingspunt van de belasting en het einde van de penant

e = 1190 mm

centrische belasting	breedte (m)	G _k (kN/m ²)	q _{G,d} (kN/m ¹)
Stalen ligger vloering + kap	0,42	16,40	6,20
Gevel / wand	5,30	2,22	10,59
			<u>16,79</u>

Excentriciteit e van de belasting is de afstand tussen het aangrijpingspunt van de belasting en het einde van de penant

e = 2320 mm

excentrische belasting	breedte (m)	lengte (m)	G _k (kN/m ²)	F _{G,d} (kN)
Stalen ligger vloering + kap	0,20	1,00	25,20	4,54
Verdiepingsvloer	1,60	1,10	5,00	7,92
Gevel / wand	1,00	2,65	2,22	5,29
				<u>17,75</u>

Totale bovenbelasting = 57,71 kN

Excentriciteit totale belasting = 1538 mm

Materiaalgegevens

materiaal	kalkzandsteen
hechting	lijmmortel
materiaalfactor	1,5
rekenwaarde druksterkte	f _d = 4,41 N/mm ²
rekenwaarde afschuifsterkte	f _{v;k;d} = 0,27 N/mm ²

Bepaling opneembaar moment

$$\lambda_x = 57713 / (0,643 * 4,41 * 120) = 170 \text{ mm}$$

$$e_u = 1538 - 0,354 * 169,7 = 1477 \text{ mm}$$

$$M_u = 1,477 * 57,71 = 85,3 \text{ kNm}$$

$$M_{Rd} = 0,8 * 85,3 = 68,2 \text{ kNm}$$

Bepaling opneembare dwarskracht

$$V_{Ed} = 169,66 * 120 * 0,27 / 1000 + 57,7 * 0,4 = 28,5 \text{ kN}$$

Controle opneembare belastingen 1e bouwlaag

Optredende belastingen

$$V_{Ed} = 1,35 * (15,4 + 7,2 + 6,7) = 39,6 \text{ kN}$$

$$M_{Ed} = 1,35 * (2,8 * 29,3) = 110,8 \text{ kNm}$$

Opneembaar bij wind van links

$$M_{Rd} = 112,91 \text{ kNm (som van de actieve penanten)}$$

$$V_{Rd} = 68,99 \text{ kN (som van de actieve penanten)}$$

$$u.c. = 0,98$$

3.9 Controle oplegging op metselwerk

Gecontroleerd is de ligger in de rechterzijgevel t.p.v. de entree.

Basis belasting:

Belastingen	breedte (m)	factor	G _k (kN/m ²)	Q _k (kN/m ²)	ψ ₀	q _{g,k} (kN/m ¹)	q _{o,k} (kN/m ¹)
Dakconstructie	1,00	100%	1,13	0,09	0,00	1,13	0,00
Verdiepingsvloer	2,70	100%	5,00	2,55	1,00	13,50	6,89
Gevel / wand	1,50	100%	2,00	0,00	0,00	3,00	0,00
						<u>17,63</u>	<u>6,89</u>

F_{perm.}; stalen ligger in rechterzijgevel t.p.v. de entree = 18,70 kN

F_{ver.}; stalen ligger in rechterzijgevel t.p.v. de entree = 12,50 kN

Berekening van een twee zijdig gesteunde wand of kolom met een rechthoekige doorsnede en een over de volle lengte constante 1^e orde excentriciteit, met controle oplegspanning, volgens NEN-EN 1996-1-1.

Algemene gegevens en afmetingen

dikte metselwerk	t =	100 mm
hoogte wand	h =	2700 mm
diepte van oplegvlak	l ₁ =	0 mm
lengte tot o.k. oplegvlak	h _c =	2700 mm
opleglengte	a ₁ =	100 mm
oplegbreedte	a _b =	200 mm
afst. tot rand wand links	a _{1,l} =	800 mm
afst. tot rand wand rechts	a _{1,r} =	0 mm
veiligheidsklasse		CC 1
aansluitende constructie		Beton onder en boven
reductiefactor	ρ ₂ =	0,75
lengte verstijwingswand 1	l =	0 mm
dikte verstijwingswand 1	t =	0 mm
lengte verstijwingswand 2	l =	0 mm
dikte verstijwingswand 2	t =	0 mm
reductiefactor	ρ _n =	0,75
effectieve hoogte	h _{eff} =	2025 mm
slankheid	λ =	20,25
lengte eff. dragend opp.	l _{ef} = b =	979 mm

Materiaalgegevens

materiaal	kalkzandsteen
hechting	lijmmortel
perforaties	≤ 25%
materiaalfactor	Y _m = 1,5
gemiddelde druksterkte	f _b = 12,0 N/mm ²
rep. druksterkte mortel	f _m = 7,5 N/mm ²
constanten	K = 0,80
	a = 0,85
	b = 0,00
vormfactor	d = 1,00
karakteristieke druksterkte	f _k = 6,61 N/mm ²
rekenwaarde druksterkte	f _d = 4,38 N/mm ²
karak. buigtreksterkte	f _{xk1} = 0,40 N/mm ²
rekenw. buigtreksterkte	f _{xd1} = 0,27 N/mm ²

Belastingen

Reactie oplegging	N _G =	18,7 kN
	N _Q =	12,5 kN
Basisbelasting wand	q _G =	17,6 kN/m
	q _Q =	6,9 kN/m

excentriciteit belasting	e =	0 mm
excentriciteit belasting	e =	0 mm

Resultaten knik

fundamentele combinatie		1	2
normaaldrukkracht	N _{Ed} =	64,8	54,3 kN
buigend moment	M _{0d} =	0,0	0,0 kNm
e _{init}	e _{init} =	16,0	16,0 mm
maximale excentriciteit	e _{mk}	16,0	16,0 mm
	A1 =	0,7	0,7
	u =	1,3	1,3
reductiefactor	φ _m	0,29	0,29
rekenwaarde druksterkte	N _{R;d} =	126,4	126,0 kN
	N _{E;d} /N _{R;d} =	0,51	0,43

Resultaten momentwerking

N _{Ed} =	64,8 kN
M _{0d} =	0,0 kNm
σ _{Ed} =	-0,66 N/mm ² >
σ _{Md} =	0,00 N/mm ²
σ _d =	-0,66 N/mm ² < 0,27 N/mm ²
u.c. =	momentwerking niet maatgevend

voldoet

Controle oplegspanning

oppervlak oplegging	A _{br} =	20000 mm ²
eff. dragend oppervlak	A _{ef} =	97942 mm ²
vergrotingsfactor	c _{br} =	1,25
uiterst opn. oplegkracht	F _{R;d} =	109,5 kN
	F _{E;d} /F _{R;d} =	0,34

oplegging voldoet

3.10 Gewichtsberekening

Balk A *Rechterzijgevel*

Belastingen	breedte (m)	factor	G _k (kN/m ²)	Q _k (kN/m ²)	ψ ₀	q _{g,k} (kN/m ¹)	q _{o,k} (kN/m ¹)
Q1							
Dakconstructie	2,80	100%	1,13	0,09	0,00	3,17	0,00
Zoldervloer	1,95	100%	0,50	2,25	0,40	0,98	1,76
Verdiepingsvloer	2,70	100%	5,00	2,55	1,00	13,50	6,89
Beganegrondvloer	2,70	100%	4,60	2,55	1,00	12,42	6,89
Gevel / wand	4,30	100%	4,00	0,00	0,00	17,20	0,00
						<u>47,27</u>	<u>15,53</u>

Belastingen	breedte (m)	factor	G _k (kN/m ²)	Q _k (kN/m ²)	ψ ₀	q _{g,k} (kN/m ¹)	q _{o,k} (kN/m ¹)
Q2							
Dakconstructie	2,80	100%	1,13	0,09	0,00	3,17	0,00
Zoldervloer	1,95	100%	0,50	2,25	1,00	0,98	4,39
Verdiepingsvloer	1,60	100%	5,00	2,55	1,00	8,00	4,08
Beganegrondvloer	1,60	100%	4,60	2,55	0,40	7,36	1,63
Gevel / wand	4,30	100%	4,00	0,00	0,00	17,20	0,00
						<u>36,71</u>	<u>10,10</u>

Balk B *t.p.v. stabiliteitswand*

Belastingen	breedte (m)	factor	G _k (kN/m ²)	Q _k (kN/m ²)	ψ ₀	q _{g,k} (kN/m ¹)	q _{o,k} (kN/m ¹)
Q1							
Zoldervloer	0,00	100%	0,50	2,25	0,40	0,00	0,00
Verdiepingsvloer	1,60	100%	5,00	2,55	1,00	8,00	4,08
Beganegrondvloer	2,70	100%	4,60	2,55	1,00	12,42	6,89
Gevel / wand	2,70	100%	2,22	0,00	0,00	5,99	0,00
						<u>26,41</u>	<u>10,97</u>

Balk C *Linkerzijgevel*

Belastingen	breedte (m)	factor	G _k (kN/m ²)	Q _k (kN/m ²)	ψ ₀	q _{g,k} (kN/m ¹)	q _{o,k} (kN/m ¹)
Q1							
Dakconstructie	2,80	100%	1,13	0,09	0,00	3,17	0,00
Zoldervloer	1,95	100%	0,50	2,25	0,40	0,98	1,76
Verdiepingsvloer	2,70	100%	5,00	2,55	1,00	13,50	6,89
Beganegrondvloer	2,70	100%	4,60	2,55	1,00	12,42	6,89
Gevel / wand	4,30	100%	4,00	0,00	0,00	17,20	0,00
						<u>47,27</u>	<u>15,53</u>

Belastingen	breedte (m)	factor	G _k (kN/m ²)	Q _k (kN/m ²)	ψ ₀	q _{g,k} (kN/m ¹)	q _{o,k} (kN/m ¹)
Q2							
Dakconstructie	0,00	100%	1,13	0,09	1,00	0,00	0,00
Zoldervloer	0,00	100%	0,50	2,25	0,40	0,00	0,00
Verdiepingsvloer	0,00	100%	5,00	2,55	0,40	0,00	0,00
Beganegrondvloer	2,70	100%	4,60	2,55	1,00	12,42	6,89
Gevel / wand	3,00	100%	0,50	0,00	0,00	1,50	0,00
						<u>13,92</u>	<u>6,89</u>

Belastingen	breedte (m)	factor	G _k (kN/m ²)	Q _k (kN/m ²)	ψ ₀	q _{g,k} (kN/m ¹)	q _{o,k} (kN/m ¹)
Q3							
Dakconstructie	2,80	100%	1,13	0,09	0,00	3,17	0,00
Zoldervloer	1,95	100%	0,50	2,25	1,00	0,98	4,39
Verdiepingsvloer	0,00	100%	5,00	2,55	0,40	0,00	0,00
Beganegrondvloer	1,10	100%	4,60	2,55	1,00	5,06	2,81
Gevel / wand	4,30	100%	4,00	0,00	0,00	17,20	0,00
						<u>26,41</u>	<u>7,19</u>

Balk D Voorgevel

Belastingen	breedte (m)	factor	G_k (kN/m ²)	Q_k (kN/m ²)	ψ_0	$q_{g,k}$ (kN/m ¹)	$q_{o,k}$ (kN/m ¹)
Dakconstructie	1,50	100%	1,13	0,09	0,00	1,70	0,00
Zoldervloer	1,25	100%	0,50	2,25	0,40	0,63	1,13
Verdiepingsvloer	0,50	100%	5,00	2,55	1,00	2,50	1,28
Beganegrondvloer	0,50	100%	4,60	2,55	1,00	2,30	1,28
Gevel / wand	6,00	100%	4,00	0,00	0,00	24,00	0,00
Gevel / wand	3,00	100%	0,50	0,00	0,00	1,50	0,00
						<u>32,62</u>	<u>3,68</u>

Balk E Stabiliteitswand

Belastingen	breedte (m)	factor	G_k (kN/m ²)	Q_k (kN/m ²)	ψ_0	$q_{g,k}$ (kN/m ¹)	$q_{o,k}$ (kN/m ¹)
Dakconstructie	2,80	100%	1,13	0,09	0,00	3,17	0,00
Zoldervloer	2,80	100%	0,50	2,25	0,40	1,40	2,52
Verdiepingsvloer	0,50	100%	5,00	2,55	1,00	2,50	1,28
Beganegrondvloer	0,50	100%	4,60	2,55	1,00	2,30	1,28
Gevel / wand	5,40	100%	2,22	0,00	0,00	11,99	0,00
						<u>21,36</u>	<u>5,07</u>

Balk F Achtergevel

Belastingen	breedte (m)	factor	G_k (kN/m ²)	Q_k (kN/m ²)	ψ_0	$q_{g,k}$ (kN/m ¹)	$q_{o,k}$ (kN/m ¹)
Dakconstructie	2,00	100%	1,13	0,09	0,00	2,27	0,00
Zoldervloer	1,80	100%	0,50	2,25	0,40	0,90	1,62
Verdiepingsvloer	0,50	100%	5,00	2,55	1,00	2,50	1,28
Beganegrondvloer	0,50	100%	4,60	2,55	1,00	2,30	1,28
Gevel / wand	6,00	100%	4,00	0,00	0,00	24,00	0,00
Gevel / wand	3,00	100%	0,50	0,00	0,00	1,50	0,00
						<u>33,47</u>	<u>4,17</u>

Puntlasten rechterzijgevel t.p.v. de entree

Belastingen	breedte (m)	lengte (m)	factor	G_k (kN/m ²)	Q_k (kN/m ²)	ψ_0	$F_{g,k}$ (kN)	$F_{o,k}$ (kN)
Dakconstructie	2,80	0,60	100%	1,13	0,09	0,00	1,90	0,00
Zoldervloer	1,95	0,60	100%	0,50	2,25	1,00	0,59	2,63
Verdiepingsvloer	2,70	0,60	100%	5,00	2,55	1,00	8,10	4,13
Gevel / wand	1,60	0,60	100%	4,00	0,00	0,00	3,84	0,00
							<u>14,43</u>	<u>6,76</u>

Puntlasten rechterzijgevel t.p.v. de woonkamer

Belastingen	breedte (m)	lengte (m)	factor	G_k (kN/m ²)	Q_k (kN/m ²)	ψ_0	$F_{g,k}$ (kN)	$F_{o,k}$ (kN)
Dakconstructie	2,80	0,80	100%	1,13	0,09	0,00	2,54	0,00
Zoldervloer	1,95	0,80	100%	0,50	2,25	1,00	0,78	3,51
Verdiepingsvloer	2,70	0,80	100%	5,00	2,55	1,00	10,80	5,51
Gevel / wand	1,60	0,80	100%	4,00	0,00	0,00	5,12	0,00
							<u>19,24</u>	<u>9,02</u>

3.11 Funderingsbalken

TS/Balkroosters

Rel: 6.01 20 jan 2016

Project..: 14300 - Plan Bull-Tabaksveld te Puiflijk
 Onderdeel: Funderingsbalken Prunus
 Dimensies: kN/m/rad
 Datum....: 19/01/2016
 Bestand..: p:\14300\algemeen\constabiel\statische berekening\prunus\funderingsbalken.grw
 Torsiefac: 15 %

Betrouwbaarheidsklasse : 1 Referentieperiode : 50
 Doorbuigingen(beton) zijn dmv gecorrigeerde stijfheden berekend.

Fysisch lineair : Er is gerekend met de e-modulus uit de materiaaltabel.
 Fys.NLE.kort : Er is gerekend met een gecorrigeerde e-modulus (korte duur).
 Deze e-mod. is berekend mbv de krachten uit de fysisch lineair berekening.

Toegepaste normen volgens Eurocode met Nederlandse NB

Belastingen	NEN-EN 1990:2002	C2:2010	NB:2011(nl)
	NEN-EN 1991-1-1:2002	C1:2009	NB:2011(nl)
Beton	NEN-EN 1992-1-1:2011(nl)	C2:2011(nl)	NB:2011(nl)

GEOMETRIE

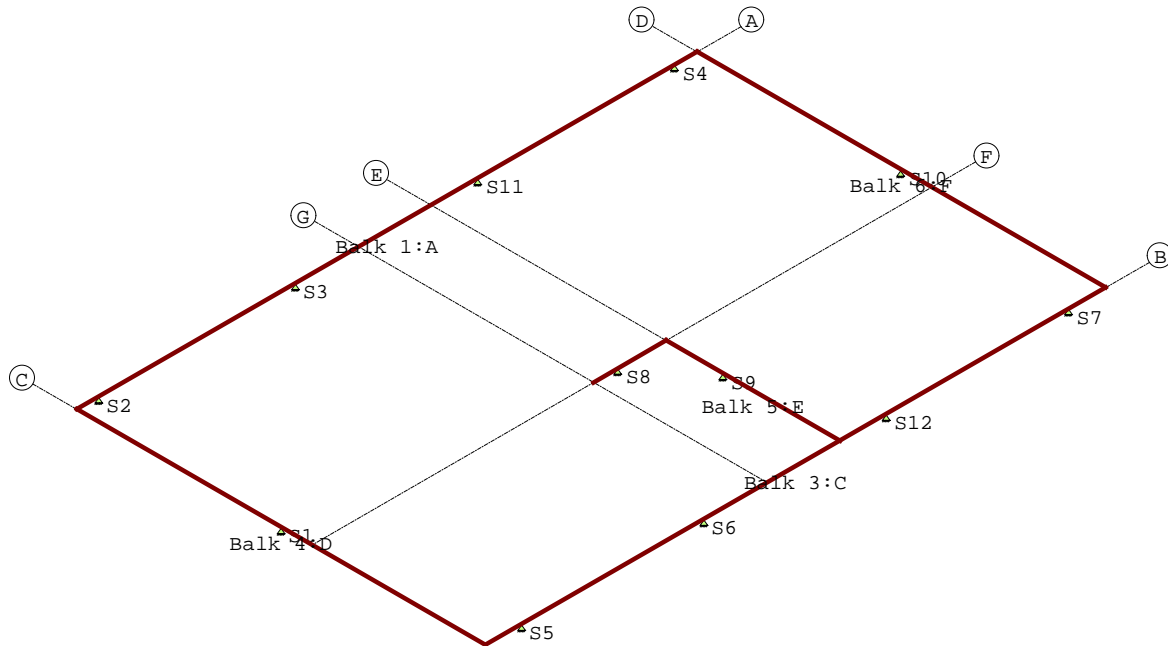

MATERIALEN

Mt	Omschrijving	E-mechanica[N/mm ²]	Kruipcoef.	S.M.	Pois.
1	C20/25	7480	3.01	25.0	0.20

PROFIELEN [mm]

Prof.	Omschrijving	Materiaal	Oppervlak	Torsietr.	Traagheid
1	B*H 400*500	1:C20/25	2.000e+005	5.577e+009	4.167e+009

PROFIELEN vervolg [mm]

Nr.	Vormf.	Breedte	Hoogte	Zs	Rek.As	Type	b1	h1	b2	h2
1	0.00	400	500	250	0.00	0:RH				

PROFIELVORMEN [mm]

1	B*H 400*500
---	-------------



STRAMIENLIJNEN

Nr.	Naam	X-begin	Y-begin	X-eind	Y-Eind
1	A	0.000	8.500	0.000	0.000
2	B	5.600	8.500	5.600	0.000
3	C	0.000	0.000	5.600	0.000
4	D	0.000	8.500	5.600	8.500
5	E	0.000	4.860	5.600	4.860
6	F	3.220	8.500	3.220	0.000
7	G	0.000	3.860	5.600	3.860

BALKEN

Nr.	Naam	Begin	Eind	Profiel
1	A	A;C	A;D	1:B*H 400*500
2	B	F;G	E;F	1:B*H 400*500
3	C	B;C	B;D	1:B*H 400*500
4	D	A;C	B;C	1:B*H 400*500
5	E	E;F	B;E	1:B*H 400*500
6	F	A;D	B;D	1:B*H 400*500

BALKEN vervolg

Nr.	Naam	Aansl.begin	Aansl.eind	Excentr.	Pasm.begin	Pasm.eind	Opm.
1	A	WDM	WDM	0.000	0.000	0.000	
2	B	WDM	WDM	0.000	0.000	0.000	
3	C	WDM	WDM	0.000	0.000	0.000	
4	D	WDM	WDM	0.000	0.000	0.000	
5	E	WDM	WDM	0.000	0.000	0.000	
6	F	WDM	WDM	0.000	0.000	0.000	

Opmerkingen:

De torsie traagheid van alle balken is tot 15% gereduceerd

STEUNPUNTYPEN

Nr.	: 1	Rotatie	X:Vrij
Afmeting	: Rond 300	Verplaatsing	Z:Veerwaarde: 50000
Min.afst.:	0.500	Rotatie	Y:Vrij

STEUNPUNTEN

Nr.	Steunpunttype	Balk	Positie	Excentr.	Opm:
1	1:Rond 300	Balk 4:D	2.800	0.000	
2	1:Rond 300	Balk 1:A	0.300	0.000	
3	1:Rond 300	Balk 1:A	3.000	0.000	
4	1:Rond 300	Balk 1:A	8.200	0.000	
5	1:Rond 300	Balk 3:C	0.500	0.000	
6	1:Rond 300	Balk 3:C	3.000	0.000	
7	1:Rond 300	Balk 3:C	8.000	0.000	
8	1:Rond 300	Balk 2:B	0.340	0.000	
9	1:Rond 300	Balk 5:E	0.780	0.000	
10	1:Rond 300	Balk 6:F	2.800	0.000	
11	1:Rond 300	Balk 1:A	5.500	0.000	
12	1:Rond 300	Balk 3:C	5.500	0.000	

BELASTINGGEVALLEN

B.G.	Omschrijving	Belast/onbelast	Ψ_0	Ψ_1	Ψ_2	e.g.
1	Permanent	2:Permanent EN1991				-1.00
2	Veranderlijk	0:Alles tegelijk	0.40	0.50	0.30	0.00

BELASTINGGEVALLEN

B.G.	Omschrijving	Type
1	Permanent	1 Permanente belasting
2	Veranderlijk	2 Ver. bel. pers. ed. (p_rep)

VELDBELASTINGEN

B.G:1 Permanent

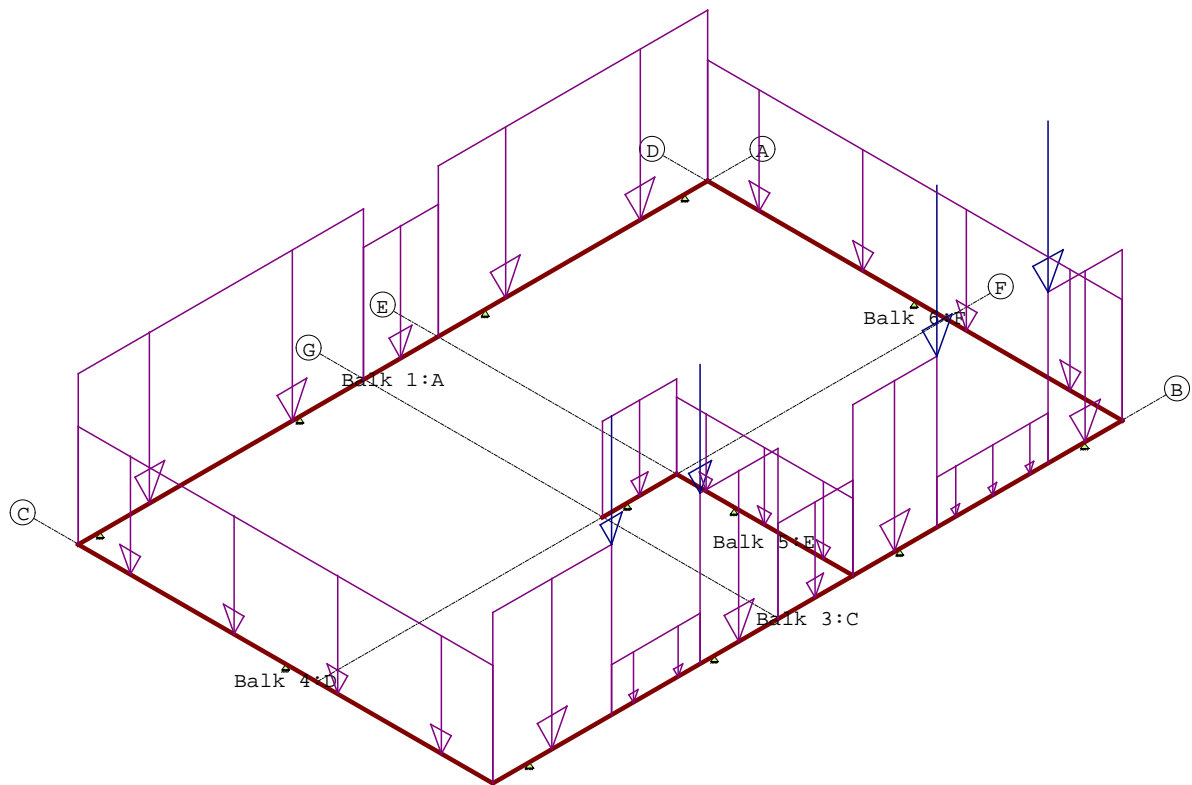

VELDBELASTINGEN

B.G:1 Permanent

Balk	Last Type	q1/p/m	q2	Afstand	Lengte	Exc.
Balk 1:A	1 1:q-last	-47.270	-47.270	0.000	3.850	0.000
Balk 1:A	2 1:q-last	-47.270	-47.270	4.860	3.640	0.000
Balk 1:A	3 1:q-last	-36.710	-36.710	3.850	1.010	0.000
Balk 2:B	1 1:q-last	-26.410	-26.410	0.000	1.000	0.000
Balk 3:C	1 1:q-last	-47.270	-47.270	0.000	1.600	0.000
Balk 3:C	2 1:q-last	-13.920	-13.920	1.600	1.200	0.000
Balk 3:C	3 1:q-last	-47.270	-47.270	2.800	1.050	0.000
Balk 3:C	4 1:q-last	-26.410	-26.410	3.850	1.010	0.000
Balk 3:C	5 1:q-last	-47.270	-47.270	4.860	1.140	0.000
Balk 3:C	6 1:q-last	-13.920	-13.920	6.000	1.500	0.000
Balk 3:C	7 1:q-last	-47.270	-47.270	7.500	1.000	0.000
Balk 3:C	8 8:Puntlast	-14.430		1.600		0.000
Balk 3:C	9 8:Puntlast	-14.430		2.800		0.000
Balk 3:C	10 8:Puntlast	-19.240		6.000		0.000
Balk 3:C	11 8:Puntlast	-19.240		7.500		0.000
Balk 4:D	1 1:q-last	-32.620	-32.620	0.000	5.600	0.000
Balk 5:E	1 1:q-last	-21.360	-21.360	0.000	2.380	0.000
Balk 6:F	1 1:q-last	-33.470	-33.470	0.000	5.600	0.000

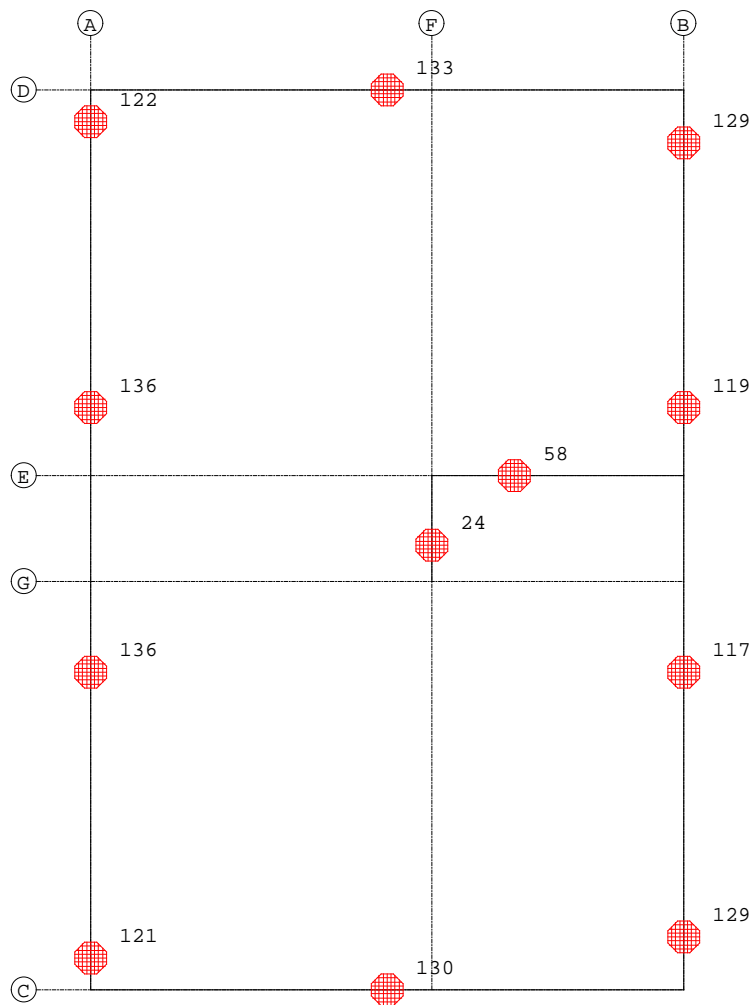

REACTIES Fysisch lineair

B.G:1 Permanent

Balk	Stp	MX	Z	MY
1	2	0.00	121.01	0.00
1	3	0.00	136.20	0.00
1	11	0.00	135.53	0.00
1	4	0.00	122.03	0.00
2	8	0.00	24.43	0.00
3	5	0.00	128.92	0.00
3	6	0.00	116.53	0.00
3	12	0.00	119.47	0.00
3	7	0.00	129.00	0.00
4	1	0.00	130.29	0.00
5	9	0.00	58.05	0.00
6	10	0.00	132.95	0.00

1354.40 : Som reacties
 -1354.40 : Som belastingen

VELDBELASTINGEN

B.G:2 Veranderlijk

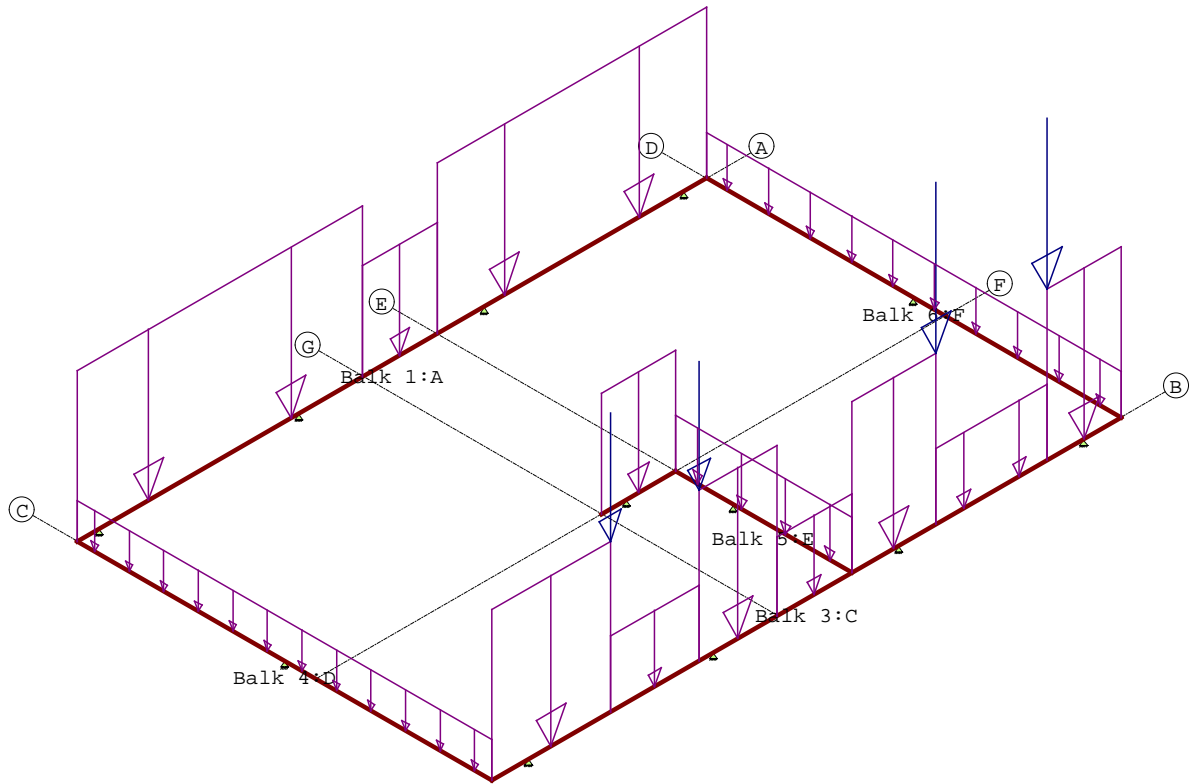

VELDBELASTINGEN

B.G:2 Veranderlijk

Balk	Last Type	q1/p/m	q2	Afstand	Lengte	Exc.
Balk 1:A	1 1:q-last	-15.530	-15.530	0.000	3.850	0.000
Balk 1:A	2 1:q-last	-10.100	-10.100	3.850	1.010	0.000
Balk 1:A	3 1:q-last	-15.530	-15.530	4.860	3.640	0.000
Balk 2:B	1 1:q-last	-10.970	-10.970	0.000	1.000	0.000
Balk 3:C	1 1:q-last	-15.530	-15.530	0.000	1.600	0.000
Balk 3:C	2 1:q-last	-6.890	-6.890	1.600	1.200	0.000
Balk 3:C	3 1:q-last	-15.530	-15.530	2.800	1.050	0.000
Balk 3:C	4 1:q-last	-7.190	-7.190	3.850	1.010	0.000
Balk 3:C	5 1:q-last	-15.530	-15.530	4.860	1.140	0.000
Balk 3:C	6 1:q-last	-6.890	-6.890	6.000	1.500	0.000
Balk 3:C	7 1:q-last	-15.530	-15.530	7.500	1.000	0.000
Balk 3:C	8 8:Puntlast	-6.760		1.600		0.000
Balk 3:C	9 8:Puntlast	-6.760		2.800		0.000
Balk 3:C	10 8:Puntlast	-9.020		6.000		0.000
Balk 3:C	11 8:Puntlast	-9.020		7.500		0.000
Balk 4:D	1 1:q-last	-3.680	-3.680	0.000	5.600	0.000
Balk 5:E	1 1:q-last	-5.070	-5.070	0.000	2.380	0.000
Balk 6:F	1 1:q-last	-4.170	-4.170	0.000	5.600	0.000

REACTIES Fysisch lineair

B.G:2 Veranderlijk

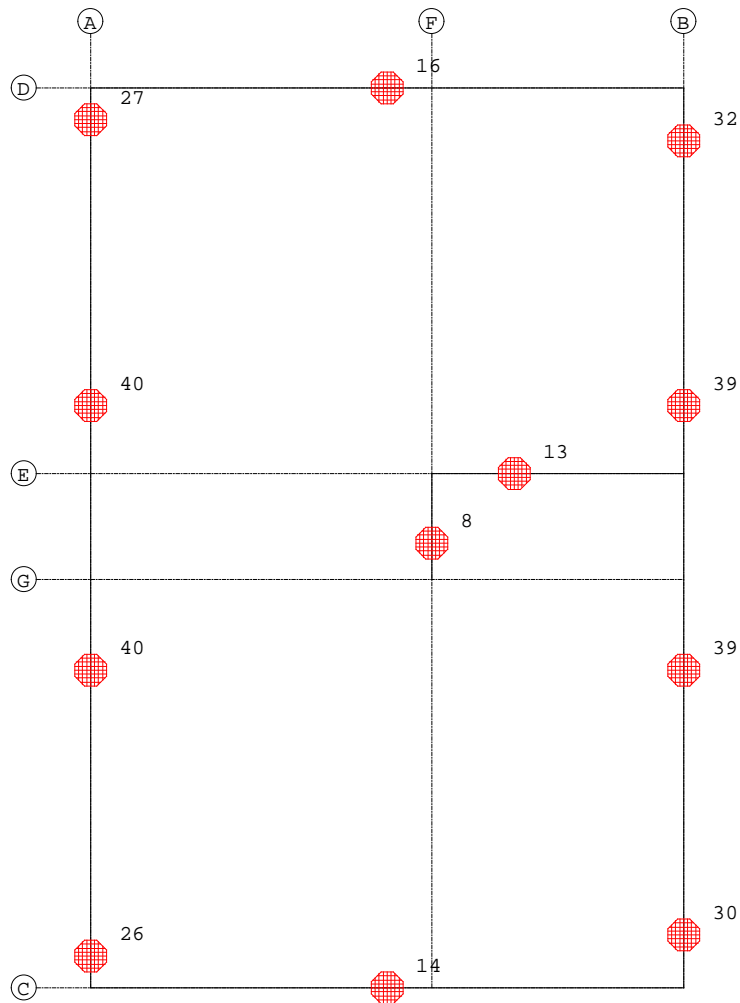

REACTIES Fysisch lineair

B.G:2 Veranderlijk

Balk	Stp	MX	Z	MY
1	2	0.00	26.48	0.00
1	3	0.00	40.08	0.00
1	11	0.00	39.73	0.00
1	4	0.00	27.00	0.00
2	8	0.00	8.10	0.00
3	5	0.00	30.06	0.00
3	6	0.00	38.79	0.00
3	12	0.00	39.18	0.00
3	7	0.00	32.16	0.00
4	1	0.00	14.31	0.00
5	9	0.00	13.45	0.00
6	10	0.00	16.01	0.00

325.33 : Som reacties
 -325.33 : Som belastingen

BELASTINGCOMBINATIES

BC	Type	BG	Gen.	Factor	BG	Gen.	Factor	BG	Gen.	Factor	BG	Gen.	Factor
1	Fund.	1	Perm	1.08	2	Extr	1.35						
2	Fund.	1	Perm	1.22	2	psi0	1.35						
3	Kar.	1	Perm	1.00	2	Extr	1.00						
4	Kar.	1	Perm	1.00	2	psi0	1.00						
5	Quas.	1	Perm	1.00	2	psi2	1.00						
6	Freq.	1	Perm	1.00	2	psi1	1.00						
7	Blij.	1	Perm	1.00									

OMHULLENDE VAN DE FUNDAMENTELE COMBINATIES

MOMENTEN Fysisch lineair

Fundamentele combinatie

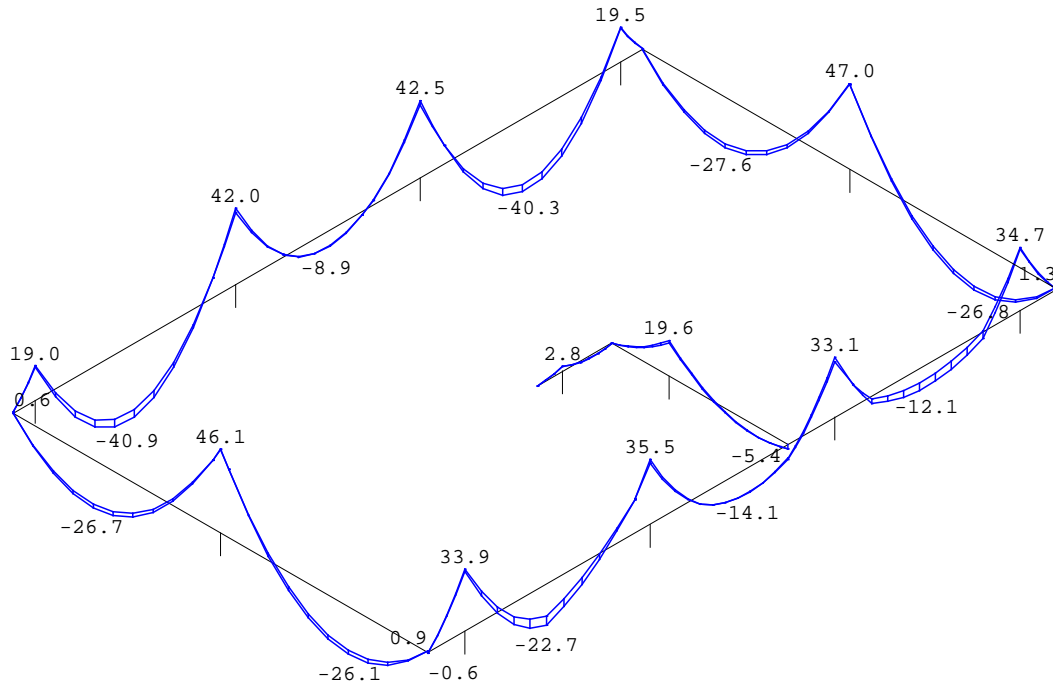

DWARSKRACHTEN Fysisch lineair

Fundamentele combinatie

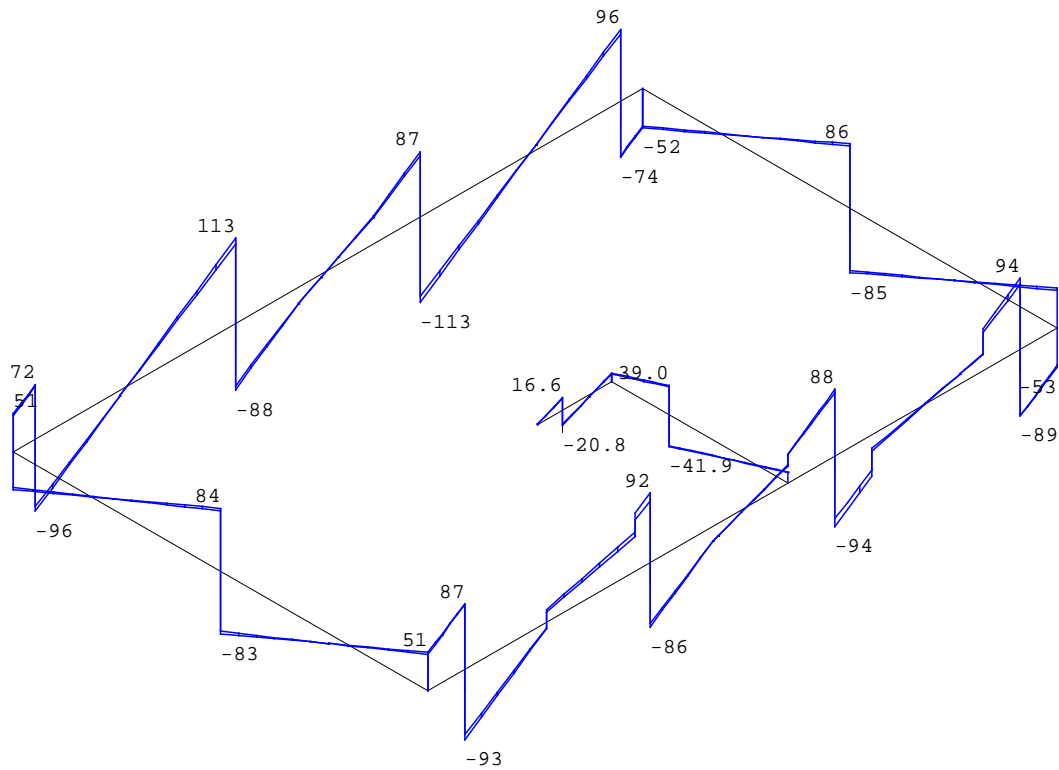

WRINGMOMENTEN Fysisch lineair

Fundamentele combinatie

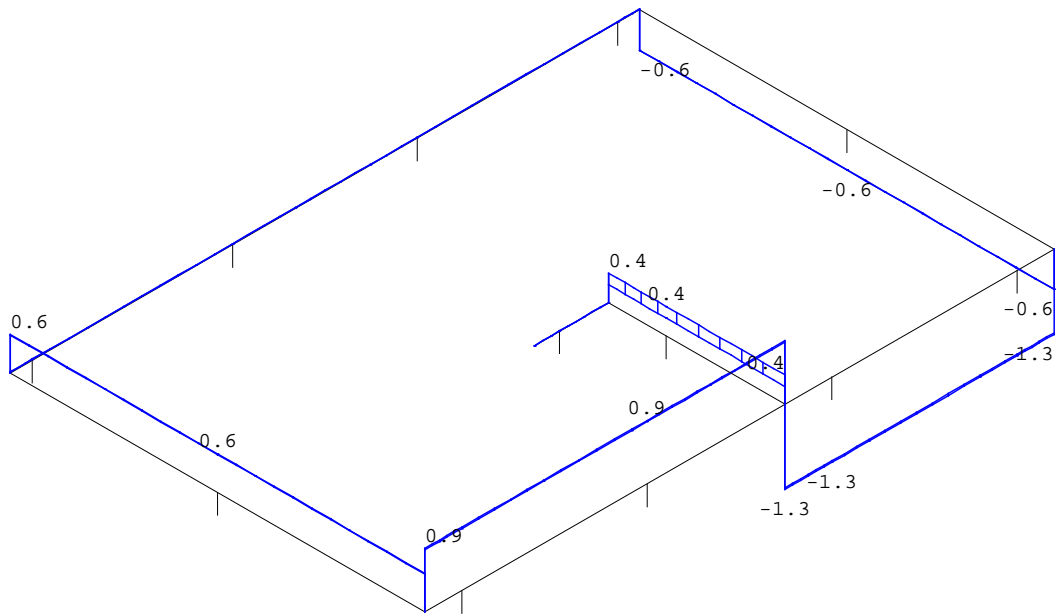

REACTIES Fysisch lineair

Fundamentele combinatie

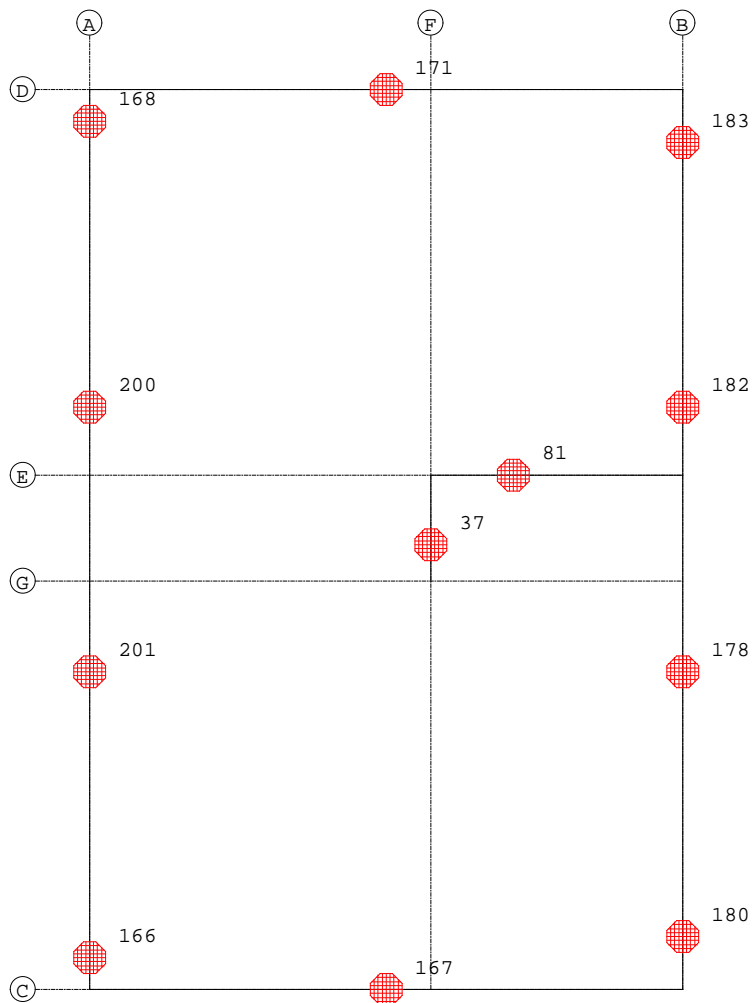

REACTIES Fysisch lineair

Fundamentele combinatie

Balk	Stp	MX		Z		MY	
		min.	max.	min.	max.	min.	max.
1	2	0.00	0.00	161.93	166.44	0.00	0.00
1	3	0.00	0.00	187.81	201.20	0.00	0.00
1	11	0.00	0.00	186.80	200.01	0.00	0.00
1	4	0.00	0.00	163.46	168.24	0.00	0.00
2	8	0.00	0.00	34.18	37.32	0.00	0.00
3	5	0.00	0.00	173.51	179.81	0.00	0.00
3	6	0.00	0.00	163.11	178.22	0.00	0.00
3	12	0.00	0.00	166.90	181.91	0.00	0.00
3	7	0.00	0.00	174.74	182.73	0.00	0.00
4	1	0.00	0.00	160.02	166.68	0.00	0.00
5	9	0.00	0.00	78.08	80.85	0.00	0.00
6	10	0.00	0.00	165.20	170.84	0.00	0.00

OMHULLENDE VAN DE KARAKTERISTIEKE COMBINATIES

VERPLAATSINGEN [mm] Fys.NLE.kort

Karakteristieke combinatie

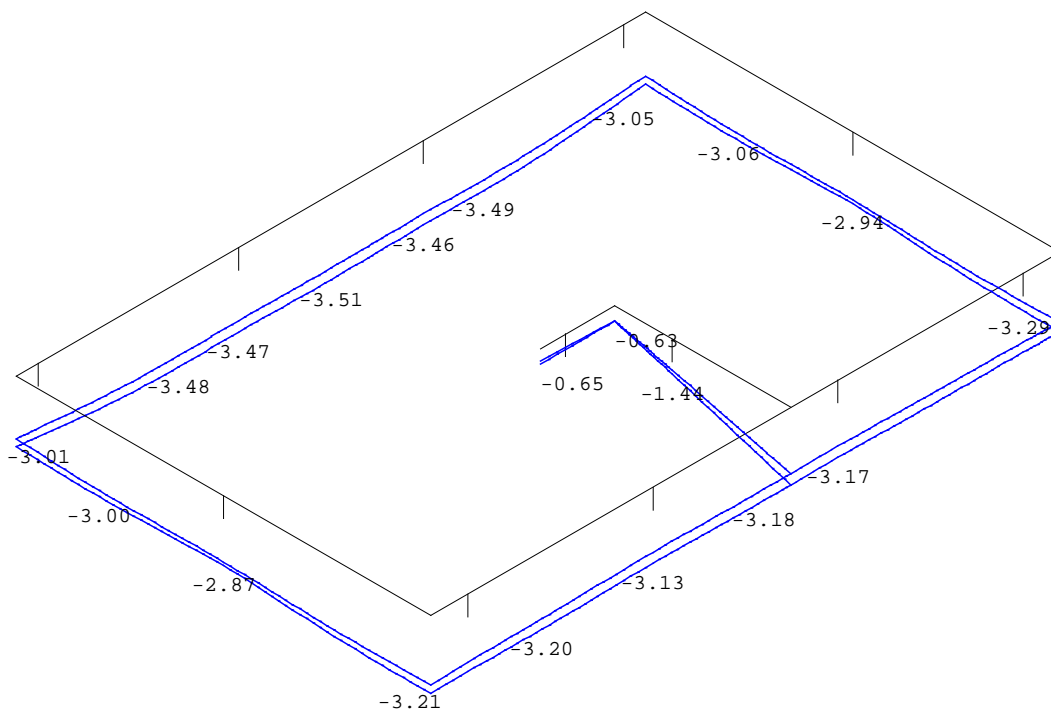

PROFIELGEGEVENS Balk

[N][mm]

t.b.v. profiel:1 B*BH 400*500

Algemeen

Materiaal : C20/25
 Oppervlak : 2.000000e+005
 Staaftype : 0: normaal
 Traagheid : 4.1667e+009
 Vormfactor : 0.00

Doorsnede

breedte : 400 hoogte : 500 zwaartepunt tov onderkant : 250
 Referentie : Boven

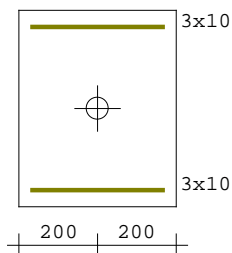

Fictieve dikte : 222.2

Breedte lastvlak a_b 6.1(10) : 0

Betonkwaliteit element : C20/25 Kruipcoëf. : 3.010

Soort spanningsrekdiagram	:	Parabolisch - rechthoekig diagram		
Staal kwaliteit hoofdwapening	:	500	$\epsilon_{u,k}$: 2.50
Soort spanningsrekdiagram	:	Bi-lineair diagram met klimmende tak		
Staal kwaliteit beugels	:	500		
Bundels toepassen	:	Nee	Breedte stort sleuf:	50
Geprefabriceerd element	:	Nee		

Betondekking		Boven	Onder
Milieu	:	XC2	XC2
Gestort tegen bestaand beton	:	Nee	Nee
Element met plaatgeometrie	:	Nee	Nee
Specifieke kwaliteitsbeheersing	:	Nee	Nee
Oneffen beton oppervlak	:	Nee	Nee
Ondergrond	:	Glad / N.v.t.	Glad / N.v.t.
Constructieklasse	:	S4	S4
Grootste korrel	:	31.5	

Hoofdwapening	:	2de laag	2de laag
Nominale dekking	:	30	30
Toegepaste dekking	:	38	38
Toegepaste zijdekking	:	43	
Gelijkwaardige diameter	:	10	10
$C_{min,b}$ $C_{min,dur}$ ΔC_{dur}	:	10 25 0	10 25 0
C_{min} ΔC_{dev} C_{nom}	:	25 5 30	25 5 30

Beugel / Verdeelwapening	:	1ste laag	1ste laag
Nominale dekking	:	30	30
Toegepaste dekking	:	30	30
Toegepaste zijdekking	:	35	
Gelijkwaardige diameter	:	8	8
$C_{min,b}$ $C_{min,dur}$ ΔC_{dur}	:	8 25 0	8 25 0
C_{min} ΔC_{dev} C_{nom}	:	25 5 30	25 5 30

Wapening		Boven	Onder
Basiswapening buitenste laag	:	3x10	3x10
Basiswapening 2e laag	:		
H.o.h.afstand 2e laag	:	0	0
Automatisch verhogen basiswap.	:	Nee	Nee
Art. 7.3.2 minimum wapening	:	Ja	Ja
Bijlegdiameters	:	10;12;16	10;12;16
Diameter nuttige hoogte	:	10.0	10.0
Min.tussenruimte	:	50	50
Min.tussenruimte naast stortsl.	:	50	
Aanhechting	:	Automatisch	Automatisch

Beugels			
Voorkeur h.o.h. afstand	:	300;150;100;75;60;50	
Beugeldiameter	:	8	
Betonkwaliteit	:	C20/25	
Breedte t.b.v. dwarskracht	:	400	Hoogte t.b.v. dwarskr: 500
Aantal beugelsneden per beugel	:	2 Ontwerpen	
Min. hoek betondrukdiagonaal θ	:	21.8	z berekenen via: MRd

Hoofdwapening Fysisch lineair

Balk 1:A

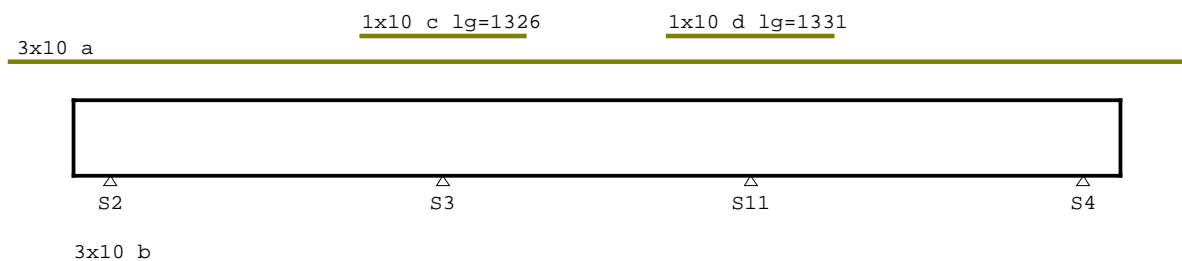

MEd dekkingslijn Fysisch lineair

Balk 1:A

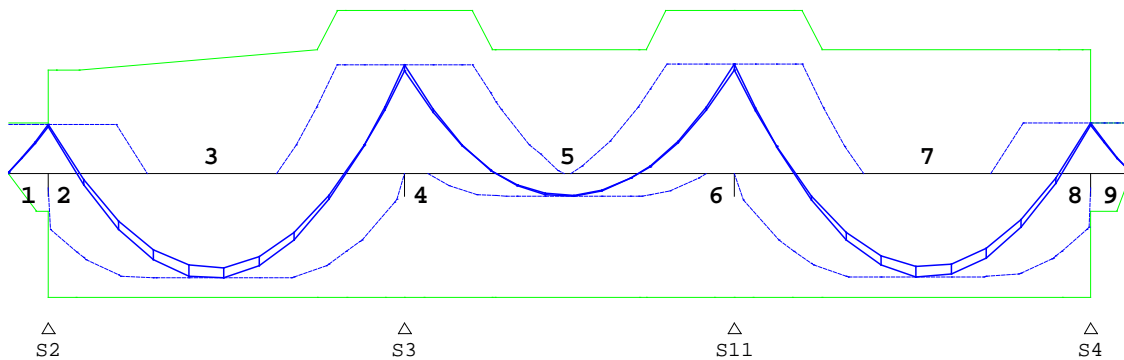

Hoofdwapening

Balk 1:A

Geb.	Pos. [mm]	M_{Ed} [kNm]	z B/O [mm]	A_b [mm ²]	A_a [mm ²]	Basiswapening +Bijlegwapening	Opm.
1	S2+0	18.98	0 Bov	228*	236	3x10	1,2
3	S2+1236	-40.89	384 Ond	202	236	3x10	
4	S3+0	42.03	422 Bov	208	236	3x10	
						79 +1x10	
6	S11+0	42.55	422 Bov	211	236	3x10	
						79 +1x10	
9	S4+0	19.46	0 Bov	234*	236	3x10	1,54,2

Opmerkingen

- [1] * = Eisen met betrekking tot minimum wapening zijn toegepast, zie nationale bijlage art. 9.2.1.1(1).
- [2] Benodigde wapening en inwendige hefboomsarm zijn bepaald volgens gedrongen ligger detaillering, zie nationale bijlage art. 6.1(10).
- [54] * = Eisen met betrekking tot minimum wapening ten behoeve van gecontroleerde scheurvorming zijn toegepast volgens art. 7.3.2.

Scheurvorming volgens artikel 7.3.3

Balk 1:A

Geb.	Pos. [mm]	$M_{E;freq}$ [kNm]	B/O	σ_s [N/mm ²]	art.	s opt. [mm]	s max. [mm]	ϕ_{km} opt. [mm]	ϕ_{km} max. [mm]	σ_b opt. [N/mm ²]	σ_b max. [N/mm ²]	Opm.
1	S2+0	15.66	Bov	155.4	7.3.3	152	300	10.0	34.0			
3	S2+1236	-30.70	Ond	304.7	7.3.3	152	159	10.0	11.5			
4	S3+0	33.04	Bov	247.9	7.3.3	101	230	10.0	16.3			
6	S11+0	33.41	Bov	250.6	7.3.3	101	227	10.0	16.1			
9	S4+0	16.06	Bov	159.4	7.3.3	152	300	10.0	34.0			

Verloop hoofdwapening

Balk 1:A

Merk	B/O	Wapening	Vanaf [mm]	Tot [mm]	Lengte [mm]	$L_{bd;begin}$ [mm]	$L_{bd;eind}$ [mm]
a	Boven	3x10	S2-819	S4+819	9537	519	519
c	Boven	1x10	S3-662	S3+664	1326	148	148
d	Boven	1x10	S11-669	S11+662	1331	148	148
b	Onder	3x10	S2-300	S4+300	8500	204	100

Opmerkingen

Alle maten zijn inclusief verschuiving van de m-lijn en verankering

DWARSKRACHTEN Fysisch lineair

Balk 1:A Fundamentele combinatie

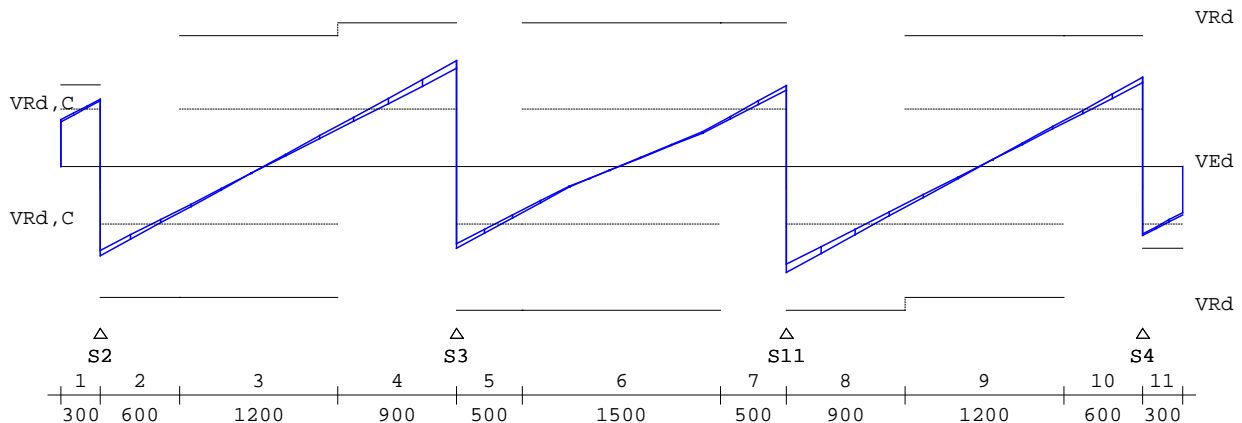

Wring- en dwarskrachtwapening

Balk 1:A

Geb.	Vanaf [mm]	Tot [mm]	Beugels	Lengte [mm]	<Wringing >		<Dwarskr.>		V_{Ed} [kN]	T_{Ed} [kNm]	Opm.
					A_{lang} [mm ²]	A_{bgl} [mm ² /m]	A_{bgl} [mm ²]	A_{opp} [mm ²]			
1	S2-300	S2+0	Ø8-300	300	0	0	286	0	72.0	0	6,59
2	S2+0	S2+600	Ø8-300	600	0	0	286	0	95.5	0	6
3	S2+600	S3-900	Ø8-300	1200	0	0	286	0	49.0	0	
4	S3-900	S3+0	Ø8-300	900	0	0	286	0	113.1	0	6
5	S3+0	S3+500	Ø8-300	500	0	0	286	0	87.7	0	6
6	S3+500	S11-500	Ø8-300	1500	0	0	286	0	49.0	0	
7	S11-500	S11+0	Ø8-300	500	0	0	286	0	86.5	0	6
8	S11+0	S11+900	Ø8-300	900	0	0	286	0	113.1	0	6
9	S11+900	S4-600	Ø8-300	1200	0	0	286	0	49.1	0	
10	S4-600	S4+0	Ø8-300	600	0	0	286	0	95.5	0	6
11	S4+0	S4+300	Ø8-300	300	0	0	286	0	73.5	0	6,59

Opmerkingen

[6] 9.2.2 (4) 50% van de dwarskrachtwapening moet uit beugels bestaan.

[59] 6.2.3: Z is berekend m.b.v. de gedrongen ligger berekening art 6.1 (10)

Wring- en dwarskrachten

Balk 1:A

Geb.	Vanaf [mm]	Tot [mm]	θ [°]	V_{Rd} [kN]	V_{Ed} [kN]	$V_{Rd,c}$ [kN]	$V_{Rd,Max}$ [kN]	T_{Ed} [kNm]	$T_{Rd,C}$ [kNm]	$T_{Rd,Max}$ [kNm]	V_{Opp} [kN]	Opm.
1	S2-300	S2+0	21.8	87	72	61	244	0	26	63	0	6,59
2	S2+0	S2+600	21.8	140	95	61	390	0	26	63	0	6
3	S2+600	S3-900	21.8	140	49	61	390	0	26	63	0	
4	S3-900	S3+0	21.8	154	113	61	429	0	26	63	0	6
5	S3+0	S3+500	21.8	154	88	61	429	0	26	63	0	6
6	S3+500	S11-500	21.8	154	49	61	429	0	26	63	0	
7	S11-500	S11+0	21.8	154	86	61	429	0	26	63	0	6
8	S11+0	S11+900	21.8	140	113	61	429	0	26	63	0	6
9	S11+900	S4-600	21.8	140	49	61	390	0	26	63	0	
10	S4-600	S4+0	21.8	140	96	61	390	0	26	63	0	6
11	S4+0	S4+300	21.8	87	74	61	244	0	26	63	0	6,59

Opmerkingen

[6] 9.2.2 (4) 50% van de dwarskrachtwapening moet uit beugels bestaan.

[59] 6.2.3: Z is berekend m.b.v. de gedrongen ligger berekening art 6.1 (10)

Hoofdwapening Fysisch lineair

Balk 2:B

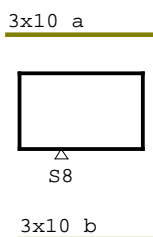

MEd dekkingslijn Fysisch lineair

Balk 2:B

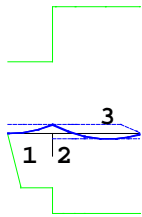

△
S8

Hoofdwapening

Balk 2:B

Geb.	Pos. [mm]	M _{Ed} [kNm]	z B/O [mm]	Ab [mm ²]	Aa [mm ²]	Basiswapening +Bijlegwapening	Opm.
1	S8+0	2.82	0 Bov	153*	236	3x10	54,2
3	S8+426	-1.60	0 Ond	153*	236	3x10	54,2

Opmerkingen

- [2] Benodigde wapening en inwendige hefboomsarm zijn bepaald volgens gedrongen ligger detaillering, zie nationale bijlage art. 6.1(10).
 [54] * = Eisen met betrekking tot minimum wapening ten behoeve van gecontroleerde scheurvorming zijn toegepast volgens art. 7.3.2.

Scheurvorming volgens artikel 7.3.3

Balk 2:B

Geb.	Pos. [mm]	M _{Ed;freq} [kNm]	B/O [mm]	σ _s [N/mm ²]	art.	s opt. [mm]	s max. [mm]	∅ _{km} opt. [mm]	∅ _{km} max. [mm]	σ _b opt. [N/mm ²]	σ _b max. [N/mm ²]	Opm.
1	S8+0	2.13	Bov	21.2	7.3.3	152	300	10.0	34.0			
3	S8+426	-1.31	Ond	13.0	7.3.3	152	300	10.0	34.0			

Verloop hoofdwapening

Balk 2:B

Merk	B/O	Wapening	Vanaf [mm]	Tot [mm]	Lengte [mm]	L _{bd;begin} [mm]	L _{bd;eind} [mm]
a	Boven	3x10	S8-440	S8+760	1200	100	100
b	Onder	3x10	S8-340	S8+760	1100	100	100

Opmerkingen

Alle maten zijn inclusief verschuiving van de m-lijn en verankering

DWARSKRACHTEN Fysisch lineair

Balk 2:B Fundamentele combinatie

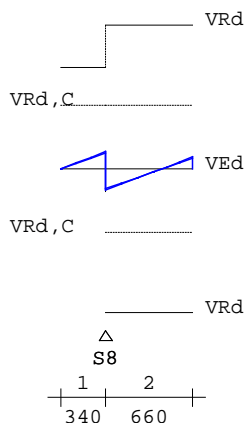

Wring- en dwarskrachtwapening

Balk 2:B

Geb.	Vanaf [mm]	Tot [mm]	Beugels	Lengte [mm]	<Wringing > <Dwarskr.>				V _{Ed} [kN]	T _{Ed} [kNm]	Opm.
					A _{lang;s} [mm ²]	A _{bg;l} [mm ² /m]	A _{bg;l} [mm ²]	A _{opp} [mm ²]			
1	S8-340	S8+0	∅8-300	340	0	0	286	0	16.4	0	59
2	S8+0	S8+660	∅8-300	660	0	0	286	0	20.6	0	59

Opmerkingen

[59] 6.2.3: z is berekend m.b.v. de gedrongen ligger berekening art 6.1 (10)

Wring- en dwarskrachten

Balk 2:B

Geb.	Vanaf [mm]	Tot [mm]	θ [°]	V_{Rd} [kN]	V_{Ed}	$V_{Rd,c}$	$V_{Rd,max}$	T_{Ed}	$T_{Rd,C}$	$T_{Rd,max}$	V_{opp}	Opm.
				-----kN-----				-----kNm-----				
1	S8-340	S8+0	21.8	98	16	61	272	0	26	63	0	59
2	S8+0	S8+660	21.8	109	21	61	385	0	26	63	0	59

Opmerkingen

[59] 6.2.3: Z is berekend m.b.v. de gedrongen ligger berekening art 6.1 (10)

Hoofdwapening Fysisch lineair

Balk 3:C

1x10 c lg=1275
3x10 a

1x10 d lg=1275

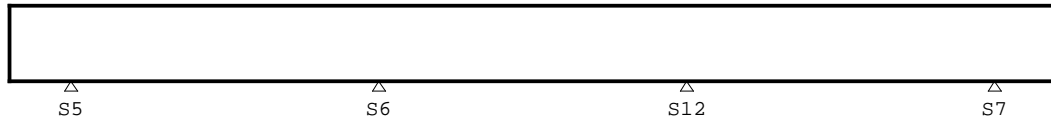

3x10 b

MED dekkingslijn Fysisch lineair

Balk 3:C

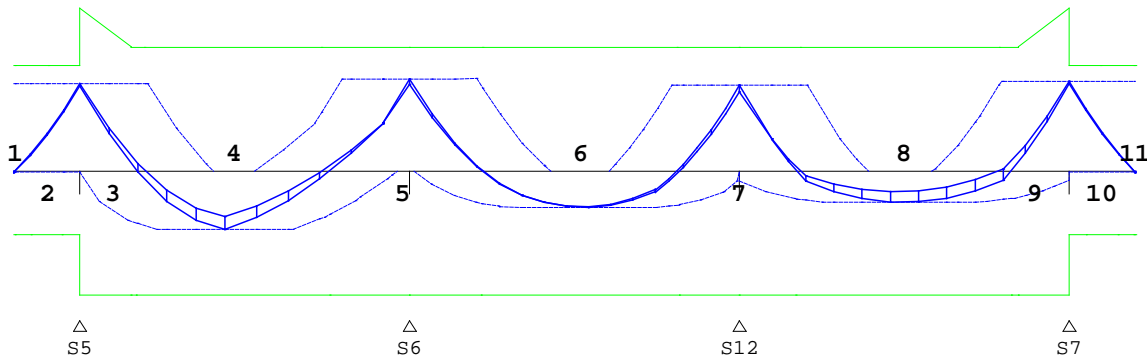

Hoofdwapening

Balk 3:C

Geb.	Pos. [mm]	M_{Ed} [kNm]	z B/O [mm]	Ab [mm ²]	Aa [mm ²]	Basiswapening +Bijlegwapening	Opm.
4	S5+1100	-22.73	384 Ond	153*	236	3x10	54
2	S5+0	33.91	300 Bov	283*	236	3x10	1,2
			Bov		79	+1x10	
5	S6+0	35.54	384 Bov	183*	236	3x10	1
10	S7+0	34.68	300 Bov	283*	236	3x10	1,2
			Bov		79	+1x10	

Opmerkingen

[1] * = Eisen met betrekking tot minimum wapening zijn toegepast, zie nationale bijlage art. 9.2.1.1(1).

[2] Benodigde wapening en inwendige hefboomsarm zijn bepaald volgens gedrongen ligger detaillering, zie nationale bijlage art. 6.1(10).

[54] * = Eisen met betrekking tot minimum wapening ten behoeve van gecontroleerde scheurvorming zijn toegepast volgens art. 7.3.2.

Scheurvorming volgens artikel 7.3.3

Balk 3:C

Geb.	Pos. [mm]	$M_{E;freq}$ [kNm]	B/O	σ_s [N/mm ²]	art.	s opt. [mm]	s max. [mm]	ϕ_{km} opt. [mm]	ϕ_{km} max. [mm]	σ_b opt. [N/mm ²]	σ_b max. [N/mm ²]	Opm.
4	S5+1100	-14.92	Ond	148.1	7.3.3	152	300	10.0	34.0			
2	S5+0	27.99	Bov	210.0	7.3.3	101	278	10.0	24.6			
5	S6+0	27.86	Bov	276.5	7.3.3	152	194	10.0	13.8			
10	S7+0	28.64	Bov	214.9	7.3.3	101	271	10.0	23.4			

Verloop hoofdwapening

Balk 3:C

Merk	B/O	Wapening	Vanaf [mm]	Tot [mm]	Lengte [mm]	$L_{bd, begin}$ [mm]	$L_{bd, eind}$ [mm]
a	Boven	3x10	S5-1019	S7+1019	9537	519	519
c	Boven	1x10	S5-888	S5+388	1275	388	388
d	Boven	1x10	S7-388	S7+888	1275	388	388
b	Onder	3x10	S5-600	S7+600	8700	100	100

Opmerkingen

Alle maten zijn inclusief verschuiving van de m-lijn en verankering

DWARSKRACHTEN Fysisch lineair

Balk 3:C Fundamentele combinatie

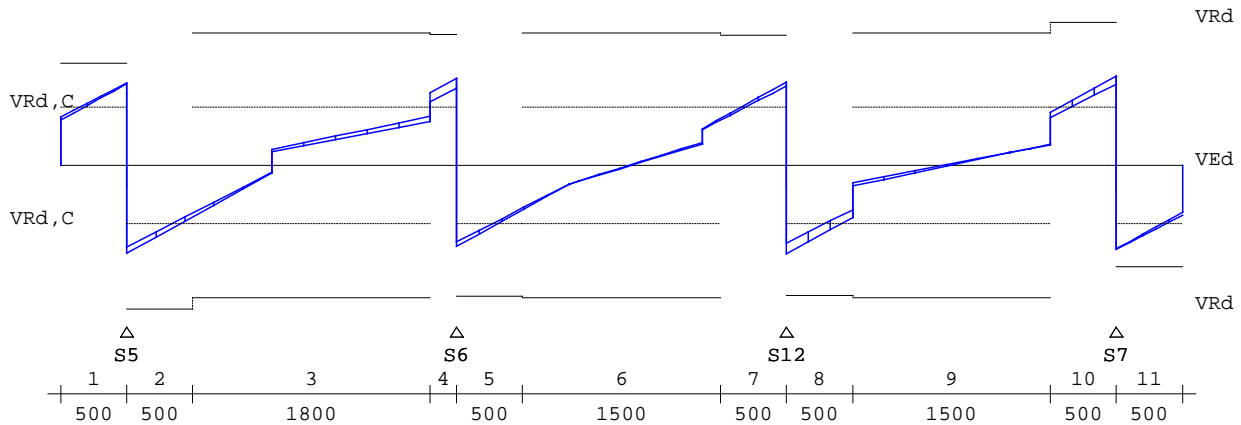

Wring- en dwarskrachtwapening

Balk 3:C

Geb.	Vanaf [mm]	Tot [mm]	Beugels	Lengte [mm]	<Wringing > <Dwarskr.>				V_{Ed} [kN]	T_{Ed} [kNm]	Opm.
					A_{lang} [mm ²]	A_{bg1} [mm ² /m]	A_{bg2} [mm ² /m]	A_{opp} [mm ²]			
1	S5-500	S5+0	Ø8-300	500	32	4	286	0	86.8	1 6,59	
2	S5+0	S5+500	Ø8-300	500	32	4	286	0	93.0	1 6	
3	S5+500	S6-200	Ø8-300	1800	0	0	286	0	54.3	1	
4	S6-200	S6+0	Ø8-300	200	32	4	286	0	92.2	1 6	
5	S6+0	S6+500	Ø8-300	500	32	4	286	0	85.5	1 6	
6	S6+500	S12-500	Ø8-300	1500	0	0	286	0	49.3	1	
7	S12-500	S12+0	Ø8-300	500	43	5	286	0	88.0	1 6	
8	S12+0	S12+500	Ø8-300	500	43	5	286	0	93.4	1 6	
9	S12+500	S7-500	Ø8-300	1500	0	0	286	0	22.5	1	
10	S7-500	S7+0	Ø8-300	500	43	5	286	0	94.1	1 6	
11	S7+0	S7+500	Ø8-300	500	43	5	286	0	88.4	1 6,59	

Opmerkingen

[6] 9.2.2 (4) 50% van de dwarskrachtwapening moet uit beugels bestaan.

[59] 6.2.3: Z is berekend m.b.v. de gedrongen ligger berekening art 6.1 (10)

Wring- en dwarskrachten

Balk 3:C

Geb.	Vanaf [mm]	Tot [mm]	θ [°]	V_{Rd} [kN]	V_{Ed} [kN]	$V_{Rd, c}$ [kN]	$V_{Rd, Max}$ [kN]	T_{Ed} [kNm]	$T_{Rd, C}$ [kNm]	$T_{Rd, Max}$ [kNm]	V_{opp} [kN]	Opm.
1	S5-500	S5+0	21.8	107	87	61	305	1	26	63	0 6,59	
2	S5+0	S5+500	21.8	144	93	61	429	1	26	63	0 6	
3	S5+500	S6-200	21.8	140	54	61	390	1	26	63	0	
4	S6-200	S6+0	21.8	137	92	61	390	1	26	63	0 6	
5	S6+0	S6+500	21.8	137	86	61	390	1	26	63	0 6	
6	S6+500	S12-500	21.8	140	49	61	390	1	26	63	0	
7	S12-500	S12+0	21.8	136	88	61	390	1	26	63	0 6	
8	S12+0	S12+500	21.8	136	93	61	390	1	26	63	0 6	
9	S12+500	S7-500	21.8	140	23	61	390	1	26	63	0	
10	S7-500	S7+0	21.8	149	94	61	429	1	26	63	0 6	
11	S7+0	S7+500	21.8	106	88	61	305	1	26	63	0 6,59	

Opmerkingen

[6] 9.2.2 (4) 50% van de dwarskrachtwapening moet uit beugels bestaan.

[59] 6.2.3: Z is berekend m.b.v. de gedrongen ligger berekening art 6.1 (10)

Hoofdwapening Fysisch lineair

Balk 4:D

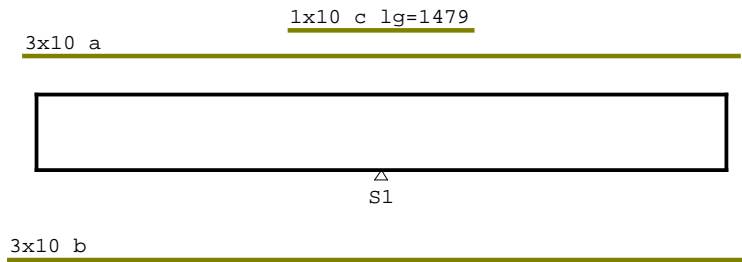

MED dekkingslijn Fysisch lineair

Balk 4:D

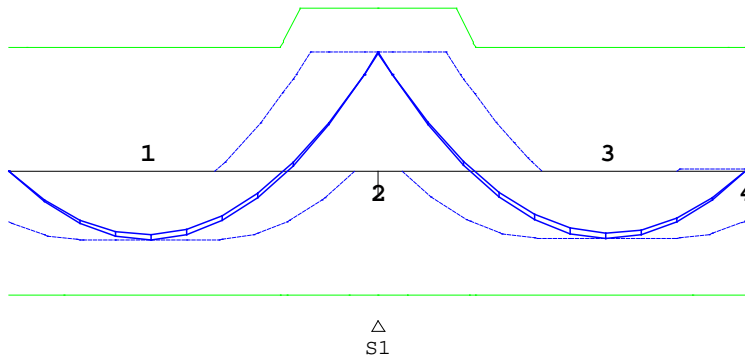

Hoofdwapening

Balk 4:D

Geb.	Pos. [mm]	M_{Ed} [kNm]	z B/O [mm]	Ab [mm ²]	Aa [mm ²]	Basiswapening +Bijlegwapening	Opm.
1	S1-1744	-26.72	384 Ond	167*	236	3x10	1
2	S1+0	46.09	422 Bov	228	236	3x10	
			Bov		79	+1x10	
4	S1+2800	0.93	384 Bov	153*	236	3x10	54

Opmerkingen

[1] * = Eisen met betrekking tot minimum wapening zijn toegepast, zie nationale bijlage art. 9.2.1.1(1).

[54] * = Eisen met betrekking tot minimum wapening ten behoeve van gecontroleerde scheurvorming zijn toegepast volgens art. 7.3.2.

Scheurvorming volgens artikel 7.3.3

Balk 4:D

Geb.	Pos. [mm]	$M_{E;freq}$ [kNm]	B/O	σ_s [N/mm ²]	art.	s opt. [mm]	s max. [mm]	σ_{km} opt. [mm]	σ_{km} max. [mm]	σ_b opt. [N/mm ²]	σ_b max. [N/mm ²]	Opm.
1	S1-1744	-21.97	Ond	218.0	7.3.3	152	267	10.0	22.6			
2	S1+0	38.11	Bov	285.9	7.3.3	101	183	10.0	13.0			
4	S1+2800	0.76	Bov	7.5	7.3.3	152	300	10.0	34.0			

Verloop hoofdwapening

Balk 4:D

Merk	B/O	Wapening	Vanaf [mm]	Tot [mm]	Lengte [mm]	$L_{bd;begin}$ [mm]	$L_{bd;eind}$ [mm]
a	Boven	3x10	S1-2900	S1+2900	5800	100	100
c	Boven	1x10	S1-739	S1+740	1479	148	148
b	Onder	3x10	S1-3023	S1+3015	6038	223	215

Opmerkingen

Alle maten zijn inclusief verschuiving van de m-lijn en verankering

DWARSKRACHTEN Fysisch lineair

Balk 4:D Fundamentele combinatie

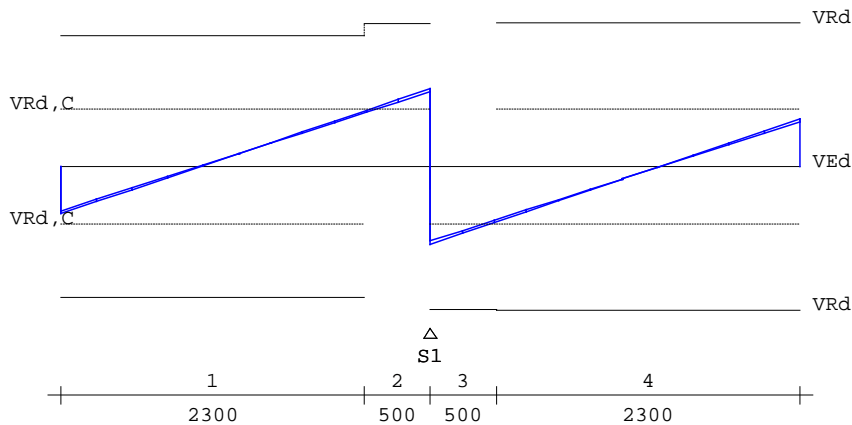

Wring- en dwarskrachtwapening

Balk 4:D

Geb.	Vanaf [mm]	Tot [mm]	Beugels	Lengte [mm]	<Wringing >		<Dwarskr.>		V_{Ed} [kN]	T_{Ed} [kNm]	Opm.
					A_{langg} [mm ²]	A_{bg1} [mm ² /m]	A_{bg1} [mm ²]	A_{opp} [mm ²]			
1	S1-2800	S1-500	Ø8-300	2300	0	0	286	0	59.4	1	
2	S1-500	S1+0	Ø8-300	500	20	2	286	0	83.4	1	6
3	S1+0	S1+500	Ø8-300	500	20	2	286	0	83.0	1	6
4	S1+500	S1+2800	Ø8-300	2300	0	0	286	0	59.1	1	

Opmerkingen

[6] 9.2.2 (4) 50% van de dwarskrachtwapening moet uit beugels bestaan.

Wring- en dwarskrachten

Balk 4:D

Geb.	Vanaf [mm]	Tot [mm]	θ [°]	V_{Rd} [kN]	V_{Ed} [kN]	$V_{Rd,C}$ [kN]	$V_{Rd,Max}$ [kN]	T_{Ed} [kNm]	$T_{Rd,C}$ [kNm]	$T_{Rd,Max}$ [kNm]	V_{opp}	Opm.
1	S1-2800	S1-500	21.8	154	59	61	390	1	26	63	0	
2	S1-500	S1+0	21.8	152	83	61	429	1	26	63	0	6
3	S1+0	S1+500	21.8	152	83	61	429	1	26	63	0	6
4	S1+500	S1+2800	21.8	140	59	61	429	1	26	63	0	

Opmerkingen

[6] 9.2.2 (4) 50% van de dwarskrachtwapening moet uit beugels bestaan.

Hoofdwapening Fysisch lineair

Balk 5:E

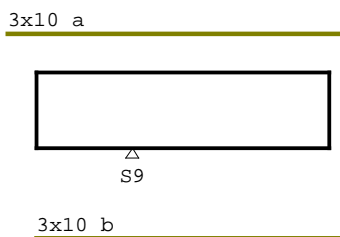

MED dekkingslijn Fysisch lineair

Balk 5:E

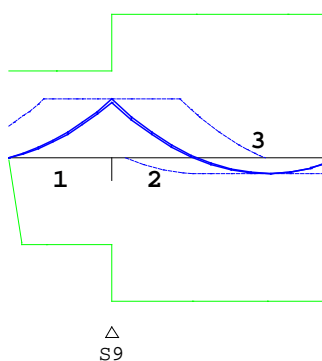

Hoofdwapening

Balk 5:E

Geb.	Pos. [mm]	M_{Ed} [kNm]	z B/O [mm]	Ab [mm ²]	Aa [mm ²]	Basiswapening +Bijlegwapening	Opm.
1	S9+0	19.64	0 Bov	160*	236	3x10	1,2
3	S9+1169	-5.38	384 Ond	153*	236	3x10	54

Opmerkingen

- [1] * = Eisen met betrekking tot minimum wapening zijn toegepast, zie nationale bijlage art. 9.2.1.1(1).
 [2] Benodigde wapening en inwendige hefboomsarm zijn bepaald volgens gedrongen ligger detaillering, zie nationale bijlage art. 6.1(10).
 [54] * = Eisen met betrekking tot minimum wapening ten behoeve van gecontroleerde scheurvorming zijn toegepast volgens art. 7.3.2.

Scheurvorming volgens artikel 7.3.3

Balk 5:E

Geb.	Pos. [mm]	$M_{E;freq}$ [kNm]	B/O [N/mm ²]	σ_s art.	s opt.	s max.	ϕ_{km} opt.	ϕ_{km} max.	σ_b opt.	σ_b max.	Opm.
1	S9+0	15.35	Bov	152.4	7.3.3	152	300	10.0	34.0		
3	S9+1169	-4.44	Ond	44.1	7.3.3	152	300	10.0	34.0		

Verloop hoofdwapening

Balk 5:E

Merk	B/O	Wapening	Vanaf [mm]	Tot [mm]	Lengte [mm]	$L_{bd;begin}$ [mm]	$L_{bd;eind}$ [mm]
a	Boven	3x10	S9-1014	S9+1700	2714	234	100
b	Onder	3x10	S9-780	S9+1700	2480	100	100

Opmerkingen

Alle maten zijn inclusief verschuiving van de m-lijn en verankering

DWARSKRACHTEN Fysisch lineair

Balk 5:E Fundamentele combinatie

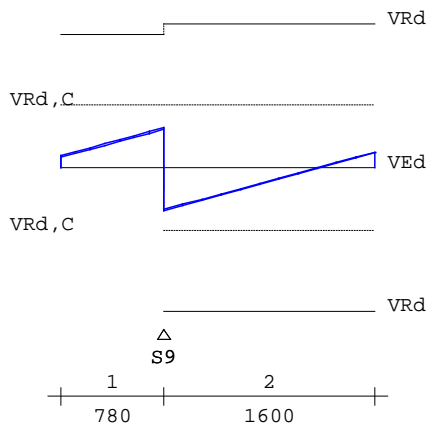

Wring- en dwarskrachtwapening

Balk 5:E

Geb.	Vanaf [mm]	Tot [mm]	Beugels	Lengte <Wringing > [mm]	<Dwarskr.>				V_{Ed} [kN]	T_{Ed} [kNm]	Opm.
					$A_{lang,s}$ [mm ²]	A_{bg1} [mm ² /m]	A_{bg1} [mm ²]	A_{oppg} [mm ²]			
1	S9-780	S9+0	Ø8-300	780	0	0	286	0	38.8	0	59
2	S9+0	S9+1600	Ø8-300	1600	0	0	286	0	41.8	0	

Opmerkingen

[59] 6.2.3: Z is berekend m.b.v. de gedrongen ligger berekening art 6.1 (10)

Wring- en dwarskrachten

Balk 5:E

Geb.	Vanaf [mm]	Tot [mm]	θ [°]	V_{Rd} [kN]	V_{Ed} [kN]	$V_{Rd,C}$ [kN]	$V_{Rd,Max}$ [kN]	T_{Ed} [kNm]	$T_{Rd,C}$ [kNm]	$T_{Rd,Max}$ [kNm]	V_{oppg} [kN]	Opm.
1	S9-780	S9+0	21.8	130	39	61	361	0	26	63	0	59
2	S9+0	S9+1600	21.8	140	42	61	390	0	26	63	0	

Opmerkingen

[59] 6.2.3: Z is berekend m.b.v. de gedrongen ligger berekening art 6.1 (10)

Hoofdwapening Fysisch lineair

Balk 6:F

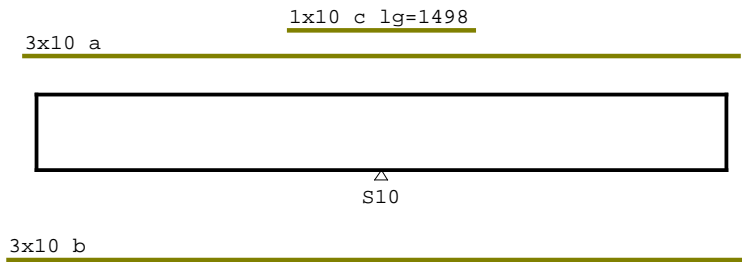

MEd dekkingslijn Fysisch lineair

Balk 6:F

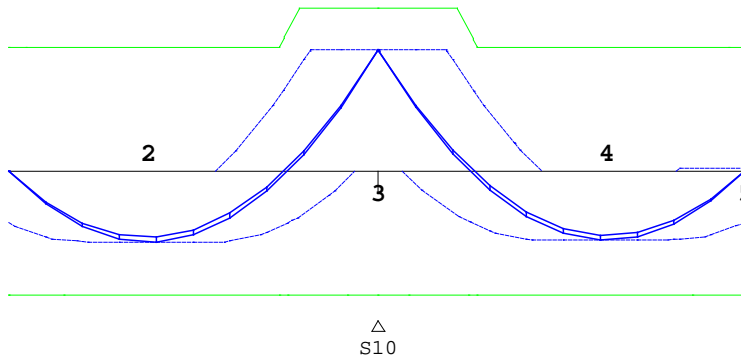

Hoofdwapening

Balk 6:F

Geb.	Pos. [mm]	M_{Ed} [kNm]	z B/O [mm]	Ab [mm ²]	Aa [mm ²]	Basiswapening +Bijlegwapening	Opm.
1	S10-2800	0.01	384 Bov	153*	236	3x10	54
2	S10-1741	-27.56	384 Ond	172*	236	3x10	1
3	S10+0	46.99	422 Bov	233	236	3x10	
			Bov		79	+1x10	
5	S10+2800	1.25	384 Bov	153*	236	3x10	54

Opmerkingen

[1] * = Eisen met betrekking tot minimum wapening zijn toegepast, zie nationale bijlage art. 9.2.1.1(1).

[54] * = Eisen met betrekking tot minimum wapening ten behoeve van gecontroleerde scheurvorming zijn toegepast volgens art. 7.3.2.

Scheurvorming volgens artikel 7.3.3

Balk 6:F

Geb.	Pos. [mm]	$M_{E;freq}$ [kNm]	B/O	σ_s [N/mm ²]	art.	s opt. [mm]	s max. [mm]	σ_{km} opt. [mm]	σ_{km} max. [mm]	σ_b opt. [N/mm ²]	σ_b max. [N/mm ²]	Opm.
1	S10-2800	0.01	Bov	0.1	7.3.3	152	300	10.0	34.0			
2	S10-1741	-22.68	Ond	225.0	7.3.3	152	259	10.0	20.8			
3	S10+0	38.87	Bov	291.6	7.3.3	101	175	10.0	12.5			
5	S10+2800	1.02	Bov	10.1	7.3.3	152	300	10.0	34.0			

Verloop hoofdwapening

Balk 6:F

Merk	B/O	Wapening	Vanaf [mm]	Tot [mm]	Lengte [mm]	$L_{bd;begin}$ [mm]	$L_{bd;eind}$ [mm]
a	Boven	3x10	S10-2900	S10+2900	5800	100	100
c	Boven	1x10	S10-749	S10+749	1498	148	148
b	Onder	3x10	S10-3030	S10+3019	6049	230	219

Opmerkingen

Alle maten zijn inclusief verschuiving van de m-lijn en verankering

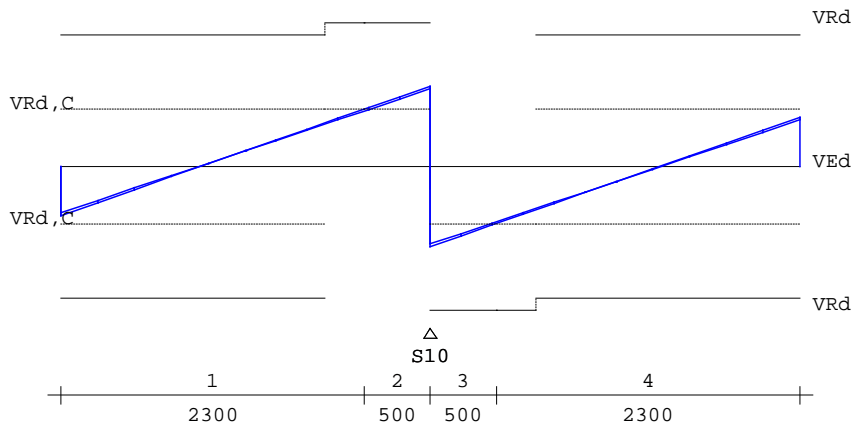

Wring- en dwarskrachtwapening

Balk 6:F

Geb.	Vanaf [mm]	Tot [mm]	Beugels	Lengte [mm]	<Wringing >		<Dwarskr.>		V_{Ed} [kN]	T_{Ed} [kNm]	Opm.
					A_{lang} [mm ²]	A_{bg1} [mm ² /m]	A_{bg2} [mm ²]	A_{opp} [mm ²]			
1	S10-2800	S10-500	Ø8-300	2300	21	2	286	0	60.9	1	
2	S10-500	S10+0	Ø8-300	500	21	2	286	0	85.5	1	6
3	S10+0	S10+500	Ø8-300	500	21	2	286	0	85.1	1	6
4	S10+500	S10+2800	Ø8-300	2300	21	2	286	0	60.5	1	

Opmerkingen

[6] 9.2.2 (4) 50% van de dwarskrachtwapening moet uit beugels bestaan.

Wring- en dwarskrachten

Balk 6:F

Geb.	Vanaf [mm]	Tot [mm]	θ [°]	V_{Rd} [kN]	V_{Ed} [kN]	$V_{Rd,C}$ [kN]	$V_{Rd,Max}$ [kN]	T_{Ed} [kNm]	$T_{Rd,C}$ [kNm]	$T_{Rd,Max}$ [kNm]	V_{opp}	Opm.
1	S10-2800	S10-500	21.8	152	61	61	429	1	26	63	0	
2	S10-500	S10+0	21.8	152	85	61	429	1	26	63	0	6
3	S10+0	S10+500	21.8	152	85	61	429	1	26	63	0	6
4	S10+500	S10+2800	21.8	152	60	61	429	1	26	63	0	

Opmerkingen

[6] 9.2.2 (4) 50% van de dwarskrachtwapening moet uit beugels bestaan.

3.12 Paal draagvermogen

Onderstaande tabellen komen uit het funderingsadvies van Koops en Romeijn met opdracht nummer 14.4068 d.d. 15 oktober 2014.

Sondering	Maaiveldniveau [m t.o.v. NAP]	Paalpuntniveau [m t.o.v. NAP]	Mortelschroefpalen		
			Rekenwaarde netto draagkracht [kN]		
			Ø 300 mm	Ø 350 mm	
001	+6,94	-5,00	480	640	
		-5,50	600	760	
		-6,00	600**	760**	
		-6,50	580	730	
		-7,00	690	960	
002	+6,99	-5,00	450	590	
		-5,50	460	600	
		-6,00	580	760	
		-6,50	700**	870**	
		-7,00	660	860	
003	+7,15	-6,00	530	710	
		-6,50	580	770	
		-7,00	580	770	
004	+7,38	-5,00	300	390	
		-5,50	420	550	
		-6,00	440	570	
		-6,50	440	570	
		-7,00	---	---	
005	+7,34	-6,00	680**	850**	
		-6,50	670	820	
		-7,00	---	---	
006	+6,94	-6,50	540	690	
		-7,00	540	690	
		-7,50	550	700	
007	+6,77	-5,00	290	400	
		-5,50	430	580	
		-6,00	490	660	
		-6,50	580	760	
		-7,00	590	790	
		-7,50	620	800	

Sondering	Maaiveldniveau [m t.o.v. NAP]	Paalpuntniveau [m t.o.v. NAP]	Mortelschroefpalen		
			Rekenwaarde netto draagkracht [kN]		
			Ø 300 mm	Ø 350 mm	
008	+6,87	-5,00	350	470	
		-5,50	380	500	
		-6,00	400	530	
		-6,50	550**	710	
		-7,00	540	710	

** : niet dieper; toepassing van een dieper paalpuntniveau leidt tot een afname van het paal draagvermogen!
 --- : sondering onvoldoende diep doorgezet voor draagvermogenberekening op dit niveau

Maximaal optredende paalreactie: $F_{Rd} = 201 \text{ kN}$

Toepassen: Mortelschroefpalen rond 300 mm met een P.P.N. van -5,0 m t.o.v. N.A.P.